

# INTERNATIONAL STANDARD

# NORME INTERNATIONALE

**Functional safety – Safety instrumented systems for the process industry sector –**

**Part 1: Framework, definitions, system, hardware and application programming requirements**

**Sécurité fonctionnelle – Systèmes instrumentés de sécurité pour le secteur des industries de transformation –**

**Partie 1: Cadre, définitions, exigences pour le système, le matériel et la programmation d'application**



千名专家 天天直播



扫码下载  
【天化云APP】

天化云—化工第一技术

直播+视频平台



re

天化云



**THIS PUBLICATION IS COPYRIGHT PROTECTED**  
**Copyright © 2016 IEC, Geneva, Switzerland**

All rights reserved. Unless otherwise specified, no part of this publication may be reproduced or utilized in any form or by any means, electronic or mechanical, including photocopying and microfilm, without permission in writing from either IEC or IEC's member National Committee in the country of the requester. If you have any questions about IEC copyright or have an enquiry about obtaining additional rights to this publication, please contact the address below or your local IEC member National Committee for further information.

Droits de reproduction réservés. Sauf indication contraire, aucune partie de cette publication ne peut être reproduite ni utilisée sous quelque forme que ce soit et par aucun procédé, électronique ou mécanique, y compris la photocopie et les microfilms, sans l'accord écrit de l'IEC ou du Comité national de l'IEC du pays du demandeur. Si vous avez des questions sur le copyright de l'IEC ou si vous désirez obtenir des droits supplémentaires sur cette publication, utilisez les coordonnées ci-après ou contactez le Comité national de l'IEC de votre pays de résidence.

IEC Central Office  
3, rue de Varembe  
CH-1211 Geneva 20  
Switzerland

Tel.: +41 22 919 02 11  
Fax: +41 22 919 03 00  
[info@iec.ch](mailto:info@iec.ch)  
[www.iec.ch](http://www.iec.ch)

#### **About the IEC**

The International Electrotechnical Commission (IEC) is the leading global organization that prepares and publishes International Standards for all electrical, electronic and related technologies.

#### **About IEC publications**

The technical content of IEC publications is kept under constant review by the IEC. Please make sure that you have the latest edition, a corrigenda or an amendment might have been published.

#### **IEC Catalogue - [webstore.iec.ch/catalogue](http://webstore.iec.ch/catalogue)**

The stand-alone application for consulting the entire bibliographical information on IEC International Standards, Technical Specifications, Technical Reports and other documents. Available for PC, Mac OS, Android Tablets and iPad.

#### **IEC publications search - [www.iec.ch/searchpub](http://www.iec.ch/searchpub)**

The advanced search enables to find IEC publications by a variety of criteria (reference number, text, technical committee,...). It also gives information on projects, replaced and withdrawn publications.

#### **IEC Just Published - [webstore.iec.ch/justpublished](http://webstore.iec.ch/justpublished)**

Stay up to date on all new IEC publications. Just Published details all new publications released. Available online and also once a month by email.

#### **Electropedia - [www.electropedia.org](http://www.electropedia.org)**

The world's leading online dictionary of electronic and electrical terms containing 20 000 terms and definitions in English and French, with equivalent terms in 15 additional languages. Also known as the International Electrotechnical Vocabulary (IEV) online.

#### **IEC Glossary - [std.iec.ch/glossary](http://std.iec.ch/glossary)**

65 000 electrotechnical terminology entries in English and French extracted from the Terms and Definitions clause of IEC publications issued since 2002. Some entries have been collected from earlier publications of IEC TC 37, 77, 86 and CISPR.

#### **IEC Customer Service Centre - [webstore.iec.ch/csc](http://webstore.iec.ch/csc)**

If you wish to give us your feedback on this publication or need further assistance, please contact the Customer Service Centre: [csc@iec.ch](mailto:csc@iec.ch).

---

#### **A propos de l'IEC**

La Commission Electrotechnique Internationale (IEC) est la première organisation mondiale qui élabore et publie des Normes internationales pour tout ce qui a trait à l'électricité, à l'électronique et aux technologies apparentées.

#### **A propos des publications IEC**

Le contenu technique des publications IEC est constamment revu. Veuillez vous assurer que vous possédez l'édition la plus récente, un corrigendum ou amendement peut avoir été publié.

#### **Catalogue IEC - [webstore.iec.ch/catalogue](http://webstore.iec.ch/catalogue)**

Application autonome pour consulter tous les renseignements bibliographiques sur les Normes internationales, Spécifications techniques, Rapports techniques et autres documents de l'IEC. Disponible pour PC, Mac OS, tablettes Android et iPad.

#### **Recherche de publications IEC - [www.iec.ch/searchpub](http://www.iec.ch/searchpub)**

La recherche avancée permet de trouver des publications IEC en utilisant différents critères (numéro de référence, texte, comité d'études,...). Elle donne aussi des informations sur les projets et les publications remplacées ou retirées.

#### **IEC Just Published - [webstore.iec.ch/justpublished](http://webstore.iec.ch/justpublished)**

Restez informé sur les nouvelles publications IEC. Just Published détaille les nouvelles publications parues. Disponible en ligne et aussi une fois par mois par email.

#### **Electropedia - [www.electropedia.org](http://www.electropedia.org)**

Le premier dictionnaire en ligne de termes électroniques et électriques. Il contient 20 000 termes et définitions en anglais et en français, ainsi que les termes équivalents dans 15 langues additionnelles. Egalement appelé Vocabulaire Electrotechnique International (IEV) en ligne.

#### **Glossaire IEC - [std.iec.ch/glossary](http://std.iec.ch/glossary)**

65 000 entrées terminologiques électrotechniques, en anglais et en français, extraites des articles Termes et Définitions des publications IEC parues depuis 2002. Plus certaines entrées antérieures extraites des publications des CE 37, 77, 86 et CISPR de l'IEC.

#### **Service Clients - [webstore.iec.ch/csc](http://webstore.iec.ch/csc)**

Si vous désirez nous donner des commentaires sur cette publication ou si vous avez des questions contactez-nous: [csc@iec.ch](mailto:csc@iec.ch).

# INTERNATIONAL STANDARD

# NORME INTERNATIONALE

---

**Functional safety – Safety instrumented systems for the process industry sector –  
Part 1: Framework, definitions, system, hardware and application programming requirements**

**Sécurité fonctionnelle – Systèmes instrumentés de sécurité pour le secteur des industries de transformation –  
Partie 1: Cadre, définitions, exigences pour le système, le matériel et la programmation d'application**

INTERNATIONAL  
ELECTROTECHNICAL  
COMMISSION

COMMISSION  
ELECTROTECHNIQUE  
INTERNATIONALE

---

ICS 13.110; 25.040.01

ISBN 978-2-8322-3159-3

**Warning! Make sure that you obtained this publication from an authorized distributor.  
Attention! Veuillez vous assurer que vous avez obtenu cette publication via un distributeur agréé.**

## CONTENTS

FOREWORD.....	5
INTRODUCTION.....	7
1 Scope.....	9
2 Normative references.....	12
3 Terms, definitions and abbreviations .....	13
3.1 Terms .....	13
3.2 Terms and definitions .....	13
3.3 Abbreviations .....	31
4 Conformance to the IEC 61511-1:2016.....	33
5 Management of functional safety.....	33
5.1 Objective .....	33
5.2 Requirements.....	33
5.2.1 General .....	33
5.2.2 Organization and resources.....	33
5.2.3 Risk evaluation and risk management.....	34
5.2.4 Safety planning .....	34
5.2.5 Implementing and monitoring.....	34
5.2.6 Assessment, auditing and revisions .....	35
5.2.7 SIS configuration management.....	37
6 Safety life-cycle requirements .....	37
6.1 Objectives.....	37
6.2 Requirements.....	38
6.3 Application program SIS safety life-cycle requirements .....	40
7 Verification .....	43
7.1 Objective .....	43
7.2 Requirements.....	43
8 Process H&RA.....	45
8.1 Objectives.....	45
8.2 Requirements.....	45
9 Allocation of safety functions to protection layers .....	46
9.1 Objectives.....	46
9.2 Requirements of the allocation process .....	46
9.3 Requirements on the basic process control system as a protection layer .....	49
9.4 Requirements for preventing common cause, common mode and dependent failures .....	50
10 SIS safety requirements specification (SRS).....	50
10.1 Objective .....	50
10.2 General requirements.....	50
10.3 SIS safety requirements .....	50
11 SIS design and engineering .....	53
11.1 Objective .....	53
11.2 General requirements.....	53
11.3 Requirements for system behaviour on detection of a fault.....	54
11.4 Hardware fault tolerance .....	55
11.5 Requirements for selection of devices.....	56

11.5.1	Objectives.....	56
11.5.2	General requirements.....	56
11.5.3	Requirements for the selection of devices based on prior use .....	56
11.5.4	Requirements for selection of FPL programmable devices (e.g., field devices) based on prior use .....	57
11.5.5	Requirements for selection of LVL programmable devices based on prior use .....	58
11.5.6	Requirements for selection of FVL programmable devices .....	59
11.6	Field devices.....	59
11.7	Interfaces.....	59
11.7.1	General .....	59
11.7.2	Operator interface requirements .....	59
11.7.3	Maintenance/engineering interface requirements .....	60
11.7.4	Communication interface requirements .....	60
11.8	Maintenance or testing design requirements .....	61
11.9	Quantification of random failure .....	61
12	SIS application program development .....	63
12.1	Objective .....	63
12.2	General requirements.....	63
12.3	Application program design .....	64
12.4	Application program implementation .....	65
12.5	Requirements for application program verification (review and testing) .....	66
12.6	Requirements for application program methodology and tools .....	67
13	Factory acceptance test (FAT) .....	68
13.1	Objective .....	68
13.2	Recommendations.....	68
14	SIS installation and commissioning .....	69
14.1	Objectives.....	69
14.2	Requirements.....	69
15	SIS safety validation .....	70
15.1	Objective .....	70
15.2	Requirements.....	70
16	SIS operation and maintenance .....	73
16.1	Objectives.....	73
16.2	Requirements.....	73
16.3	Proof testing and inspection .....	75
16.3.1	Proof testing .....	75
16.3.2	Inspection .....	76
16.3.3	Documentation of proof tests and inspection.....	76
17	SIS modification .....	76
17.1	Objectives.....	76
17.2	Requirements.....	77
18	SIS decommissioning .....	77
18.1	Objectives.....	77
18.2	Requirements.....	78
19	Information and documentation requirements .....	78
19.1	Objectives.....	78
19.2	Requirements.....	78

Bibliography .....	80
Figure 1 – Overall framework of the IEC 61511 series .....	8
Figure 2 – Relationship between IEC 61511 and IEC 61508.....	10
Figure 3 – Detailed relationship between IEC 61511 and IEC 61508 .....	11
Figure 4 – Relationship between safety instrumented functions and other functions.....	12
Figure 5 – Programmable electronic system (PES): structure and terminology.....	24
Figure 6 – Example of SIS architectures comprising three SIS subsystems .....	27
Figure 7 – SIS safety life-cycle phases and FSA stages.....	38
Figure 8 – Application program safety life-cycle and its relationship to the SIS safety life-cycle.....	41
Figure 9 – Typical protection layers and risk reduction means.....	49
Table 1 – Abbreviations used in IEC 61511 .....	32
Table 2 – SIS safety life-cycle overview (1 of 2).....	39
Table 3 – Application program safety life-cycle: overview (1 of 2).....	42
Table 4 – Safety integrity requirements: $PFD_{avg}$ .....	47
Table 5 – Safety integrity requirements: average frequency of dangerous failures of the SIF .....	47
Table 6 – Minimum HFT requirements according to SIL .....	55

## INTERNATIONAL ELECTROTECHNICAL COMMISSION

---

**FUNCTIONAL SAFETY –  
SAFETY INSTRUMENTED SYSTEMS  
FOR THE PROCESS INDUSTRY SECTOR –****Part 1: Framework, definitions, system,  
hardware and application programming requirements**

## FOREWORD

- 1) The International Electrotechnical Commission (IEC) is a worldwide organization for standardization comprising all national electrotechnical committees (IEC National Committees). The object of IEC is to promote international co-operation on all questions concerning standardization in the electrical and electronic fields. To this end and in addition to other activities, IEC publishes International Standards, Technical Specifications, Technical Reports, Publicly Available Specifications (PAS) and Guides (hereafter referred to as "IEC Publication(s)"). Their preparation is entrusted to technical committees; any IEC National Committee interested in the subject dealt with may participate in this preparatory work. International, governmental and non-governmental organizations liaising with the IEC also participate in this preparation. IEC collaborates closely with the International Organization for Standardization (ISO) in accordance with conditions determined by agreement between the two organizations.
- 2) The formal decisions or agreements of IEC on technical matters express, as nearly as possible, an international consensus of opinion on the relevant subjects since each technical committee has representation from all interested IEC National Committees.
- 3) IEC Publications have the form of recommendations for international use and are accepted by IEC National Committees in that sense. While all reasonable efforts are made to ensure that the technical content of IEC Publications is accurate, IEC cannot be held responsible for the way in which they are used or for any misinterpretation by any end user.
- 4) In order to promote international uniformity, IEC National Committees undertake to apply IEC Publications transparently to the maximum extent possible in their national and regional publications. Any divergence between any IEC Publication and the corresponding national or regional publication shall be clearly indicated in the latter.
- 5) IEC itself does not provide any attestation of conformity. Independent certification bodies provide conformity assessment services and, in some areas, access to IEC marks of conformity. IEC is not responsible for any services carried out by independent certification bodies.
- 6) All users should ensure that they have the latest edition of this publication.
- 7) No liability shall attach to IEC or its directors, employees, servants or agents including individual experts and members of its technical committees and IEC National Committees for any personal injury, property damage or other damage of any nature whatsoever, whether direct or indirect, or for costs (including legal fees) and expenses arising out of the publication, use of, or reliance upon, this IEC Publication or any other IEC Publications.
- 8) Attention is drawn to the Normative references cited in this publication. Use of the referenced publications is indispensable for the correct application of this publication.
- 9) Attention is drawn to the possibility that some of the elements of this IEC Publication may be the subject of patent rights. IEC shall not be held responsible for identifying any or all such patent rights.

International Standard IEC 61511-1 has been prepared by subcommittee 65A: System aspects, of IEC technical committee 65: Industrial-process measurement, control and automation.

This second edition cancels and replaces the first edition published in 2003. This edition constitutes a technical revision. This edition includes the following significant technical changes with respect to the previous edition:

- references and requirements to software replaced with references and requirements to application programming;
- functional safety assessment requirements provided with more detail to improve management of functional safety.
- management of change requirement added;

- security risk assessment requirements added;
- requirements expanded on the basic process control system as a protection layer;
- requirements for hardware fault tolerance modified and should be reviewed carefully to understand user/integrator options.

The text of this standard is based on the following documents:

FDIS	Report on voting
65A/777/FDIS	65A/784/RVD

Full information on the voting for the approval of this standard can be found in the report on voting indicated in the above table.

This publication has been drafted in accordance with the ISO/IEC Directives, Part 2.

A list of all parts in the IEC 61511 series, published under the general title *Functional safety – safety instrumented systems for the process industry sector*, can be found on the IEC website.

The committee has decided that the contents of this publication will remain unchanged until the stability date indicated on the IEC website under "<http://webstore.iec.ch>" in the data related to the specific publication. At this date, the publication will be

- reconfirmed,
- withdrawn,
- replaced by a revised edition, or
- amended.



## INTRODUCTION

Safety instrumented systems (SISs) have been used for many years to perform safety instrumented functions (SIFs) in the process industries. If instrumentation is to be effectively used for SIFs, it is essential that this instrumentation achieves certain minimum standards and performance levels.

The IEC 61511 series addresses the application of SISs for the process industries. The IEC 61511 series also addresses a process Hazard and Risk Assessment (H&RA) to be carried out to enable the specification for SISs to be derived. Other safety systems' contributions are only considered with respect to the performance requirements for the SIS. The SIS includes all devices necessary to carry out each SIF from sensor(s) to final element(s).

The IEC 61511 series has two concepts which are fundamental to its application: SIS safety life-cycle and safety integrity levels (SILs).

The IEC 61511 series addresses SISs which are based on the use of electrical/electronic/programmable electronic technology. Where other technologies are used for logic solvers, the basic principles of the IEC 61511 series should be applied to ensure the functional safety requirements are met. The IEC 61511 series also addresses the SIS sensors and final elements regardless of the technology used. The IEC 61511 series is process industry specific within the framework of the IEC 61508 series.

The IEC 61511 series sets out an approach for SIS safety life-cycle activities to achieve these minimum principles. This approach has been adopted in order that a rational and consistent technical policy is used.

In most situations, safety is best achieved by an inherently safe process design. However in some instances this is not possible or not practical. If necessary, this may be combined with a protective system or systems to address any residual identified risk. Protective systems can rely on different technologies (chemical, mechanical, hydraulic, pneumatic, electrical, electronic, and programmable electronic). To facilitate this approach, the IEC 61511 series:

- addresses that a H&RA is carried out to identify the overall safety requirements;
- addresses that an allocation of the safety requirements to the SIS is carried out;
- works within a framework which is applicable to all instrumented means of achieving functional safety;
- details the use of certain activities, such as safety management, which may be applicable to all methods of achieving functional safety.

The IEC 61511 series on SIS for the process industry:

- addresses all SIS safety life-cycle phases from initial concept, design, implementation, operation and maintenance through to decommissioning;
- enables existing or new country specific process industry standards to be harmonized with the IEC 61511 series.

The IEC 61511 series is intended to lead to a high level of consistency (e.g., of underlying principles, terminology, and information) within the process industries. This should have both safety and economic benefits. Figure 1 below shows an overall framework of the IEC 61511 series.

In jurisdictions where the governing authorities (e.g., national, federal, state, province, county, city) have established process safety design, process safety management, or other regulations, these take precedence over the requirements defined in the IEC 61511 series.

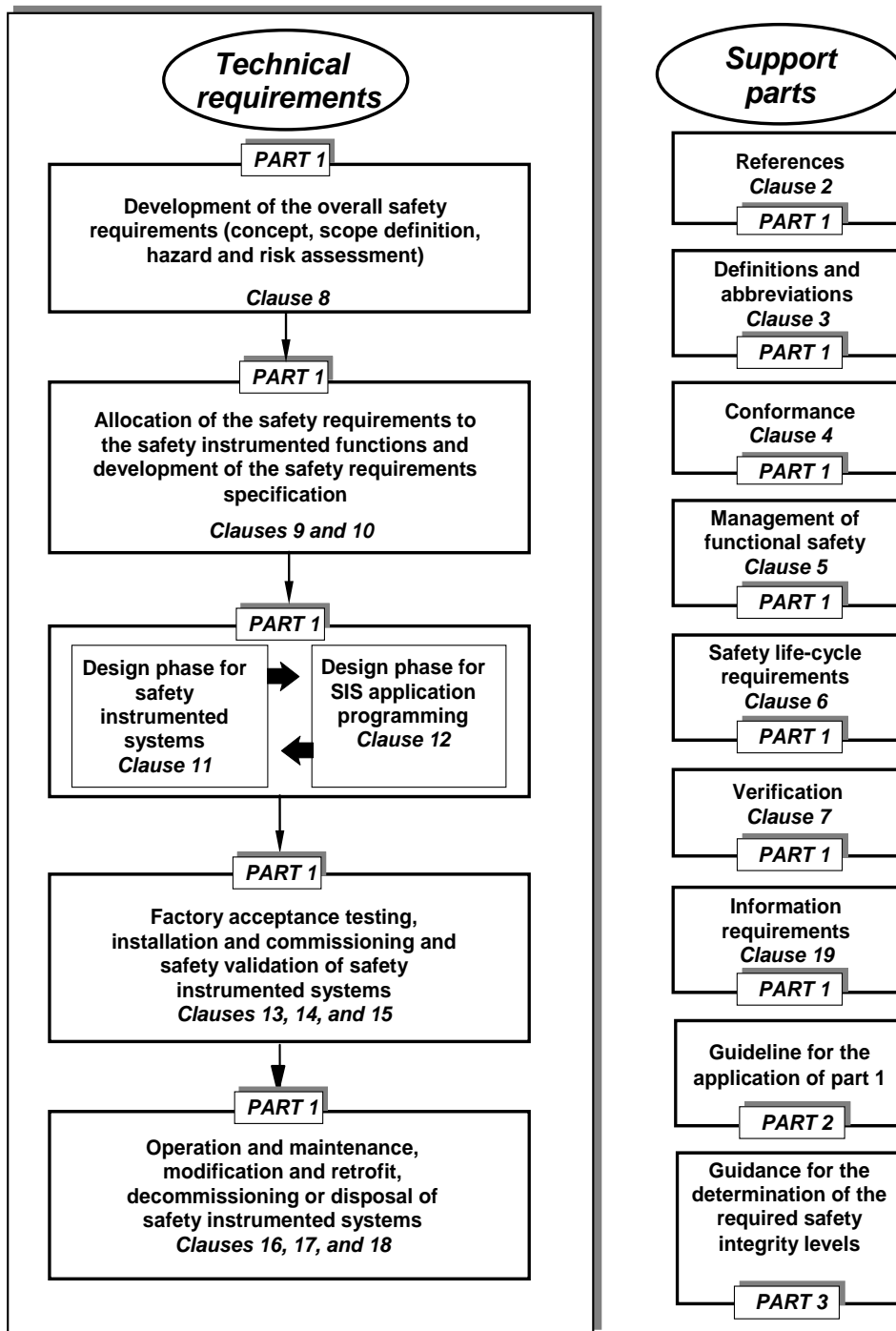

IEC

Figure 1 – Overall framework of the IEC 61511 series

# FUNCTIONAL SAFETY – SAFETY INSTRUMENTED SYSTEMS FOR THE PROCESS INDUSTRY SECTOR –

## Part 1: Framework, definitions, system, hardware and application programming requirements

### 1 Scope

This part of IEC 61511 gives requirements for the specification, design, installation, operation and maintenance of a safety instrumented system (SIS), so that it can be confidently entrusted to achieve or maintain a safe state of the process. IEC 61511-1 has been developed as a process sector implementation of IEC 61508:2010.

In particular, IEC 61511-1:

- a) specifies the requirements for achieving functional safety but does not specify who is responsible for implementing the requirements (e.g., designers, suppliers, owner/operating company, contractor). This responsibility will be assigned to different parties according to safety planning, project planning and management, and national regulations;
- b) applies when devices that meets the requirements of the IEC 61508 series published in 2010, or IEC 61511-1:2016 [11.5], is integrated into an overall system that is to be used for a process sector application. It does not apply to manufacturers wishing to claim that devices are suitable for use in SISs for the process sector (see IEC 61508-2:2010 and IEC 61508-3:2010);
- c) defines the relationship between IEC 61511 and IEC 61508 (see Figures 2 and 3);
- d) applies when application programs are developed for systems having limited variability language or when using fixed programming language devices, but does not apply to manufacturers, SIS designers, integrators and users that develop embedded software (system software) or use full variability languages (see IEC 61508-3:2010);
- e) applies to a wide variety of industries within the process sector for example, chemicals, oil and gas, pulp and paper, pharmaceuticals, food and beverage, and non-nuclear power generation;  

NOTE 1 Within the process sector some applications may have additional requirements that have to be satisfied.
- f) outlines the relationship between SIFs and other instrumented functions (see Figure 4);
- g) results in the identification of the functional requirements and safety integrity requirements for the SIF taking into account the risk reduction achieved by other methods;
- h) specifies life-cycle requirements for system architecture and hardware configuration, application programming, and system integration;
- i) specifies requirements for application programming for users and integrators of SISs.
- j) applies when functional safety is achieved using one or more SIFs for the protection of personnel, protection of the general public or protection of the environment;
- k) may be applied in non-safety applications for example asset protection;
- l) defines requirements for implementing SIFs as a part of the overall arrangements for achieving functional safety;
- m) uses a SIS safety life-cycle (see Figure 7) and defines a list of activities which are necessary to determine the functional requirements and the safety integrity requirements for the SIS;

- n) specifies that a H&RA is to be carried out to define the safety functional requirements and safety integrity levels (SIL) of each SIF;  
NOTE 2 Figure 9 presents an overview of risk reduction means.
- o) establishes numerical targets for average probability of failure on demand (in demand mode) and average frequency of dangerous failures (in demand mode or continuous mode) for each SIL;
- p) specifies minimum requirements for hardware fault tolerance (HFT);
- q) specifies measures and techniques required for achieving the specified SIL;
- r) defines a maximum level of functional safety performance (SIL 4) which can be achieved for a SIF implemented according to IEC 61511-1;
- s) defines a minimum level of functional safety performance (SIL 1) below which IEC 61511-1 does not apply;
- t) provides a framework for establishing the SIL but does not specify the SIL required for specific applications (which should be established based on knowledge of the particular application and on the overall targeted risk reduction);
- u) specifies requirements for all parts of the SIS from sensor to final element(s);
- v) defines the information that is needed during the SIS safety life-cycle;
- w) specifies that the design of the SIS takes into account human factors;
- x) does not place any direct requirements on the individual operator or maintenance person:

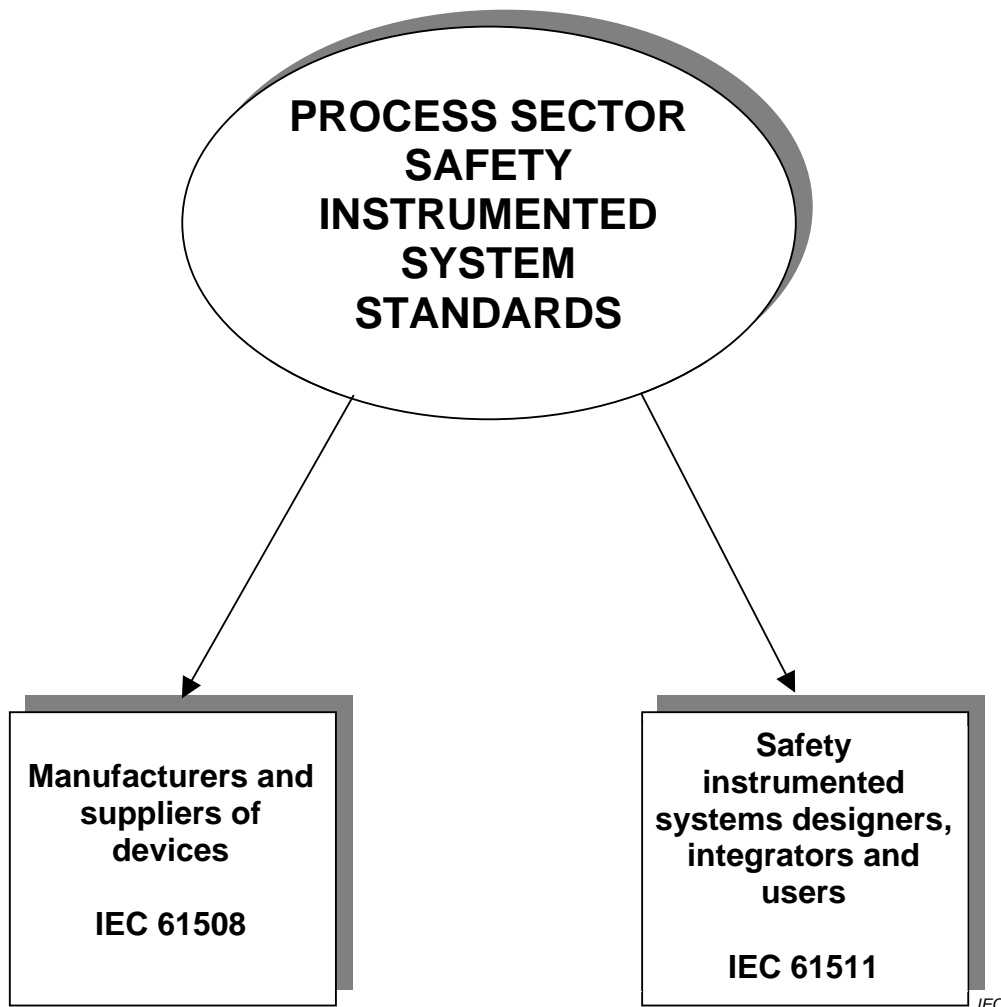

**Figure 2 – Relationship between IEC 61511 and IEC 61508**

NOTE 3 IEC 61508 is also used by safety instrumented designers, integrators and users where directed in IEC 61511.

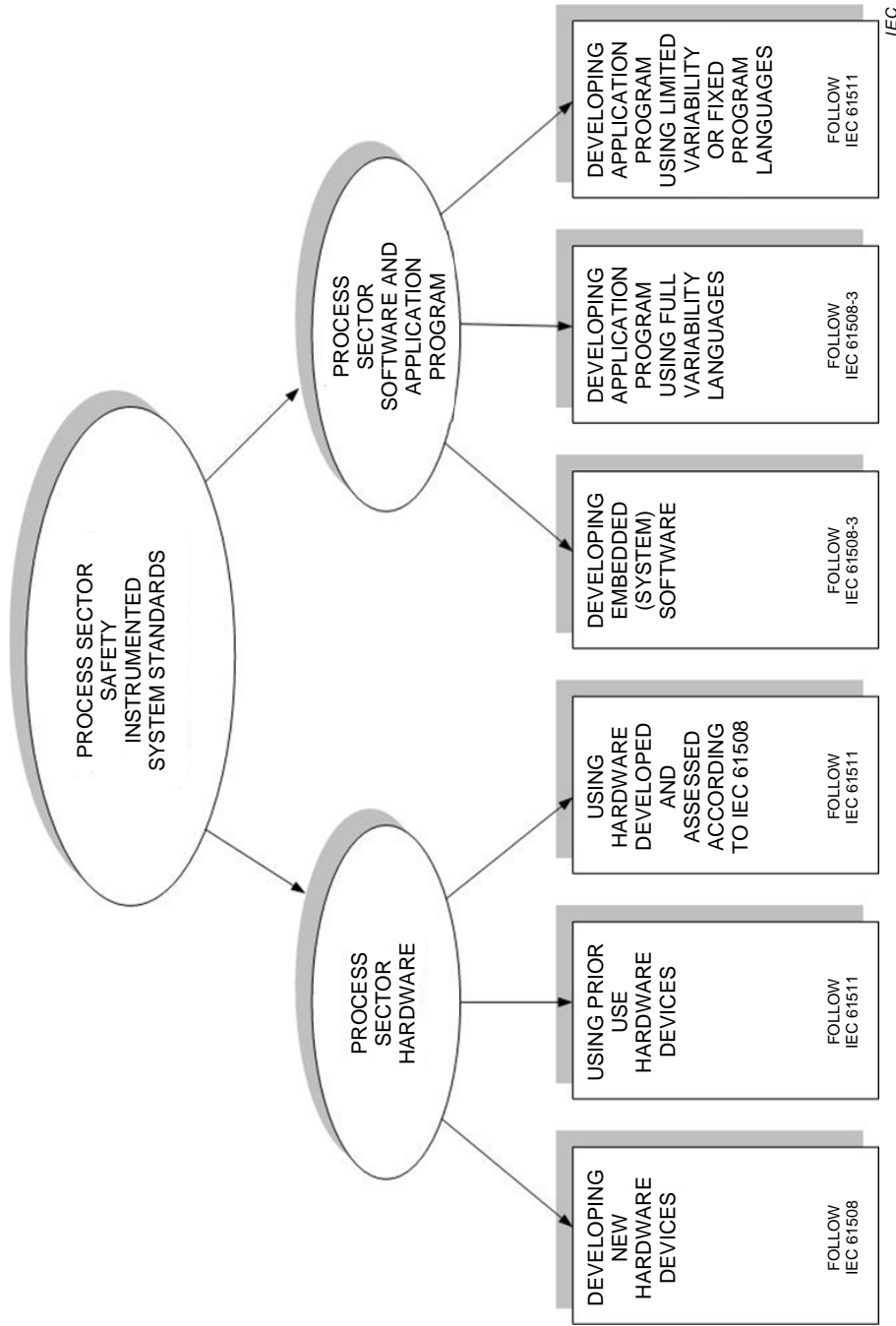

**Figure 3 – Detailed relationship between IEC 61511 and IEC 61508**

NOTE 4 Subclause 7.2.2 in IEC 61511-1:2016 and IEC 61511-2:2016 contain guidance on handling integration of sub-systems that comply with other standards (such as machinery , burner, etc.).

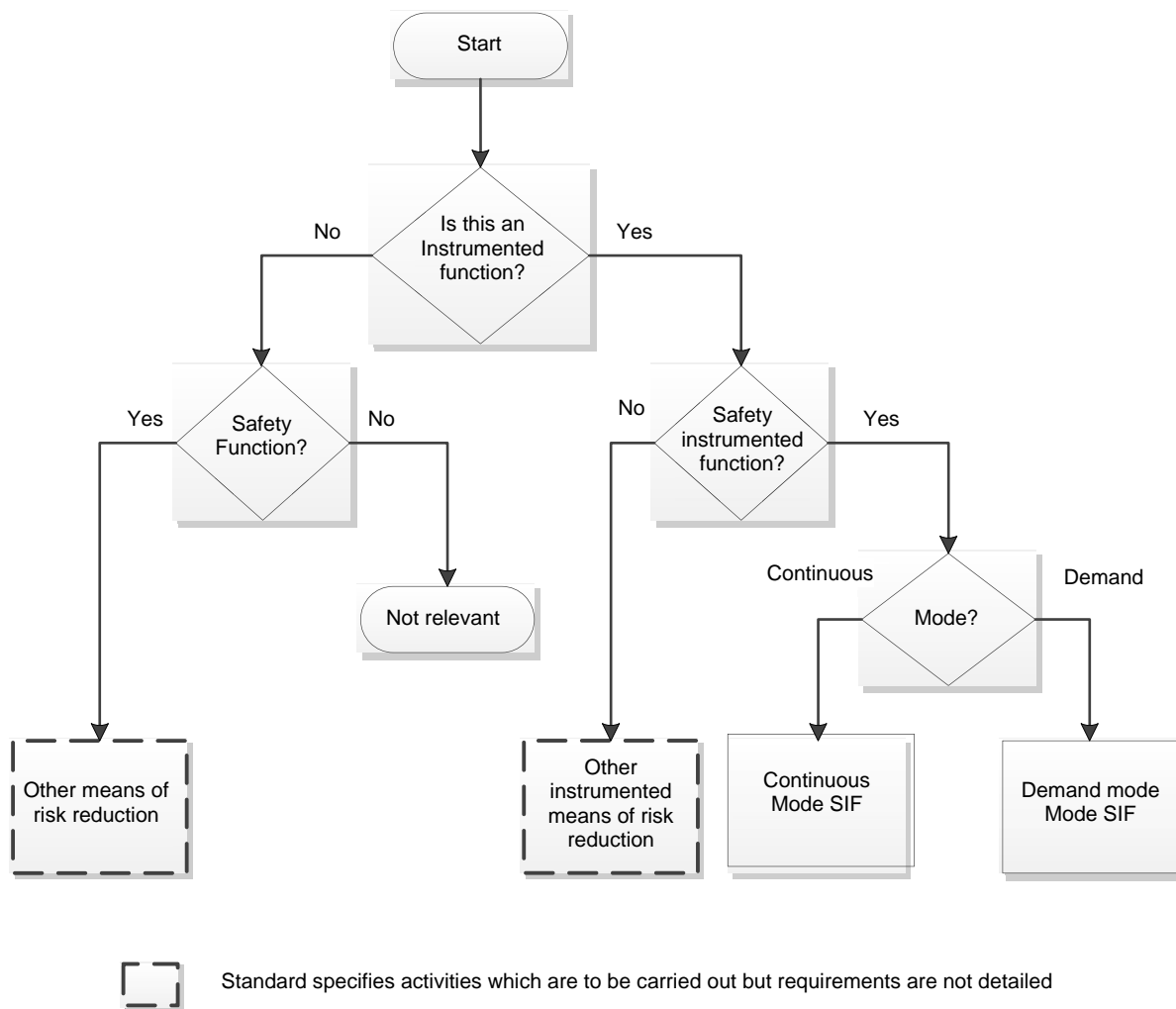

**Figure 4 – Relationship between safety instrumented functions and other functions**

## 2 Normative references

The following documents, in whole or in part, are normatively referenced in this document and are indispensable for its application. For dated references, only the edition cited applies. For undated references, the latest edition of the referenced document (including any amendments) applies.

IEC 61508-1:2010, *Functional safety of electrical/electronic/programmable electronic safety-related systems – Part 1: General Requirements*

IEC 61508-2:2010, *Functional safety of electrical/electronic/programmable electronic safety-related systems – Part 2: Requirements for electrical/electronic/programmable electronic safety-related systems*

IEC 61508-3:2010, *Functional safety of electrical/electronic/programmable electronic safety-related systems – Part 3: Software requirements*

### 3 Terms, definitions and abbreviations

#### 3.1 Terms

Terms are listed alphabetically in 3.2.

#### 3.2 Terms and definitions

For the purposes of this document, the following definitions apply.

In some cases these definitions differ from the definitions of the same terms in IEC 61508-4:2010. In some cases this is due to the terminology used in the process sector. In other cases these definitions have been aligned with other relevant definitive references (e.g., IEC 60050 the International Electrotechnical Vocabulary, ISO/IEC Guide 51:2013). However, unless otherwise stated, there is no difference in the technical meaning between these definitions and the definitions of the same terms in IEC 61508-4:2010.

##### 3.2.1

##### **architecture configuration**

specific configuration of hardware and software components in a system

Note 1 to entry: In the IEC 61511 series this can mean, for example, arrangement of SIS subsystems, the internal structure of a SIS subsystem or the internal structure of SIS application programs.

##### 3.2.2

##### **asset protection**

function allocated to a system and designed for the purpose of preventing loss or damage to assets

##### 3.2.3

##### **basic process control system BPCS**

system which responds to input signals from the process, its associated equipment, other programmable systems and/or operators and generates output signals causing the process and its associated equipment to operate in the desired manner but which does not perform any SIF

Note 1 to entry: A BPCS includes all of the devices necessary to ensure that the process operates in the desired manner.

Note 2 to entry: A BPCS typically may implement various functions such as process control functions, monitoring, and alarms.

##### 3.2.4

##### **bypass**

action or facility to prevent all or parts of the SIS functionality from being executed

Note 1 to entry: Examples of bypassing include:

- the input signal is blocked from the trip logic while still presenting the input parameters and alarm to the operator;
- the output signal from the trip logic to a final element is held in the normal state preventing final element operation;
- a physical bypass line is provided around the final element;
- preselected input state (e.g., on/off input) or set is forced by means of an engineering tool (e.g., in the application program).

Note 2 to entry: Other terms are also used to refer to bypassing, such as override, defeat, disable, force, or inhibit or muting.

##### 3.2.5

##### **channel**

device or group of devices that independently perform(s) a specified function

Note 1 to entry: The devices within a channel could include input/output (I/O) devices, logic solvers, sensors, and final elements.

Note 2 to entry: A dual channel (i.e., a two-channel) configuration is one with two channels that independently perform the same function. Channels may be identical or diverse.

Note 3 to entry: The term can be used to describe a complete system or a portion of a system (e.g., sensors or final elements).

Note 4 to entry: Channel describes SIS hardware architectural features often used to meet hardware fault tolerance requirements.

### **3.2.6 common cause**

**3.2.6.1  
common cause failures, pl**  
concurrent failures of different devices, resulting from a single event, where these failures are not consequences of each other

Note 1 to entry: All the failures due to a common cause do not necessarily occur exactly at the same time and this may allow time to detect the occurrence of the common cause before a SIF is actually failed.

Note 2 to entry: Common cause failures can also lead to common mode failures.

Note 3 to entry: The potential for common cause failures reduces the effect of system redundancy or fault tolerance (e.g., increases the probability of failure of two or more channels in a multiple channel system).

Note 4 to entry: Common cause failures are dependent failures. They may be due to external events (e.g., temperature, humidity, overvoltage, fire, and corrosion), systematic fault (e.g., design, assembly or installation errors, bugs), human error (e.g., misuse), etc.

Note 5 to entry: By extension, a common cause failure (in singular form) is a failure belonging to a set of concurrent failures (plural form) according to 3.2.6.1 definition.

**3.2.6.2  
common mode failures, pl**  
concurrent failures of different devices characterized by the same failure mode (i.e., identical faults)

Note 1 to entry: Common mode failures may have different causes.

Note 2 to entry: Common mode failures can also be the result of common cause failures (3.2.6.1).

Note 3 to entry: The potential for common mode failures reduces the effectiveness of system redundancy and fault tolerance (e.g., failure of two or more channels in the same way, causing the same erroneous result).

Note 4 to entry: By extension, a common mode failure (in singular form) is a failure belonging to a set of concurrent failures (plural form) according to 3.2.6.2 definition.

**3.2.7  
compensating measure**  
temporary implementation of planned and documented methods for managing risks during any period of maintenance or process operation when it is known that the performance of the SIS is degraded

**3.2.8  
component**  
one of the parts of a system, SIS subsystem, or device performing a specified function

Note 1 to entry: Component may also include software.



### **3.2.9 configuration management**

discipline of identifying the components and the arrangements of those components of an evolving system for the purposes of controlling changes to those components, and maintaining continuity of the system and traceability of any changes throughout the life-cycle

#### **3.2.9.1 conservative approach** cautious way of doing analysis and calculations

Note 1 to entry: In the safety field, each time an analysis, assumptions, or calculation has to be done (about models, input data, computations, etc.) it can be chosen in order to be sure to produce pessimistic results.

#### **3.2.10 control system** system which responds to input signals from the process and/or from an operator and generates output signals causing the process to operate in the desired manner

Note 1 to entry: The control system includes sensors and final elements and may be either a BPCS or a SIS or a combination of the two.

#### **3.2.11 dangerous failure** failure which impedes or disables a given safety action

Note 1 to entry: A failure is "dangerous" only with regard to a given SIF.

Note 2 to entry: When fault tolerance is implemented, a dangerous failure can lead to either:

- a degraded SIF where the safety action is available but there is either a higher PFD (demand mode of operation) or a higher likelihood of initiating a hazardous event (continuous mode of operation), or
- a disabled SIF where the safety action is completely disabled (demand mode of operation) or the hazardous event has been induced (continuous mode of operation).

Note 3 to entry: When no fault tolerance is implemented, all dangerous failures lead to a disabled SIF.

#### **3.2.12 dependent failure** failure whose probability cannot be expressed as the simple product of the unconditional probabilities of the individual events which caused it

Note 1 to entry: Two events A and B are dependent if the probability of occurrence of A and B,  $P(A \text{ and } B)$ , is greater than  $P(A) \times P(B)$ .

Note 2 to entry: See 9.4.2 and IEC 61511-3:2016, Annex J for consideration of dependent failures between protection layers.

Note 3 to entry: Dependent failures include common cause.

#### **3.2.13 detected revealed overt** relating to hardware and software failures or faults which are not hidden because they announce themselves or are discovered through normal operation or through dedicated detection methods

Note 1 to entry: There are some differences in the use of these terms:

- Overt is used for failures or faults which announce themselves when they occur (e.g., due to the change of state). The repair of such failures can begin as soon as they have occurred.
- Detected is used for failures or faults which do not announce themselves when they occur and which remain hidden until detected by some means (e.g., diagnostic tests, proof tests, operator intervention like physical inspection and manual tests). The repair of such failures can begin only after they have been revealed. See Note 2 for the specific use of this term in IEC 61511.

– Revealed is used for failures or faults that become evident due to being overt or as a result of being detected.

Note 2 to entry: In IEC 61511 and except when the context suggests another meaning, the term *dangerous detected failures/faults* is related to dangerous failures detected by diagnostic tests.

Note 3 to entry: When the detection is very fast (e.g., by diagnostic tests) then the detected failures or faults can be considered to be overt failures or faults.

When the detection is not very fast (e.g., by proof tests) the detected failures or faults cannot be considered to be overt failures or faults when addressing safety integrity levels.

Note 4 to entry: A dangerous revealed failure can only be treated as a safe failure if effective measures, automatic or manual, are taken in a short enough time to maintain process safety.

### **3.2.14 device**

hardware, with or without software, capable of performing a specified function

Note 1 to entry: Examples are sensors, logic solvers, final elements, operator interfaces, and field wiring.

#### **3.2.14.1 field device**

SIS or BPCS device connected directly to the process or located in close proximity to the process

Note 1 to entry: Examples are sensors, final elements and manual switches.

### **3.2.15 diagnostics**

frequent (in relation to the process safety time) automatic test to reveal faults

#### **3.2.15.1 diagnostics coverage**

DC

fraction of dangerous failures rates detected by diagnostics. Diagnostics coverage does not include any faults detected by proof tests

Note 1 to entry: Diagnostics coverage is typically applied to SIS devices or SIS subsystems. E.g., the diagnostics coverage is typically determined for a sensor, final element or a logic solver.

Note 2 to entry: For safety applications the diagnostics coverage is typically applied to dangerous failures of SIS devices or SIS subsystems. For example, the diagnostics coverage for the dangerous failures of a device is  $DC = \lambda_{DD}/\lambda_{DT}$ , where  $\lambda_{DD}$  is the dangerous detected failure rate and  $\lambda_{DT}$  is the total dangerous failure rate. For a SIS subsystem with internal redundancy, DC is time dependant:  $DC(t) = \lambda_{DD}(t)/\lambda_{DT}(t)$ .

Note 3 to entry: When the diagnostics coverage (DC) and the total dangerous failure rate ( $\lambda_{DT}$ ) are given, the detected ( $\lambda_{DD}$ ) and undetected dangerous failure rates ( $\lambda_{DU}$ ) can be computed as follows:

$$\lambda_{DD} = DC \times \lambda_{DT} \text{ and } \lambda_{DU} = (1-DC) \times \lambda_{DT} .$$

### **3.2.16 diversity**

different means of performing a required function

Note 1 to entry: Diversity may be achieved by different physical means, different programming techniques, or different design approaches.

### **3.2.17 error**

discrepancy between a computed, observed or measured value or condition and the true, specified or theoretically correct value or condition

[SOURCE: IEC 60050-192:2015, 192-03-02]

**3.2.18****failure**

loss of ability to perform as required

Note 1 to entry: A failure of a device is an event that results in a fault state of that device.

Note 2 to entry: When the loss of ability is caused by a latent fault, the failure occurs when a particular set of circumstances is encountered.

Note 3 to entry: Performance of required functions necessarily excludes certain behaviour, and some functions may be specified in terms of behaviour to be avoided. The occurrence of such behaviour is a failure.

Note 4 to entry: Failures are either random or systematic (see 3.2.61 and 3.2.83).

[SOURCE: IEC 60050-192:2015, 192-03-01, modified – Notes to entry have been changed]

**3.2.18.1****failure mode**

manner in which failure occurs

Note 1 to entry: A failure mode may be defined by the function lost or the state transition that occurred.

[SOURCE: IEC 60050-192:2015, 192-03-17]

**3.2.19****fault**

inability to perform as required, due to an internal state

Note 1 to entry: A fault of an item results from a failure, either of the item itself, or from a deficiency in an earlier stage of the life-cycle, such as specification, design, manufacture or maintenance.

Note 2 to entry: A fault of a device results in a failure when a particular set of circumstances is encountered.

[SOURCE: IEC 60050-192:2015, 192-04-01, modified – Some notes to entry have been changed, others have been deleted]

**3.2.20****fault avoidance**

use of techniques and procedures which aim to avoid the introduction of faults during any phase of the SIS safety life-cycle

**3.2.20.1****fault exclusion**

elimination from further consideration of faults due to improbable failure modes

Note 1 to entry: Further information about fault exclusion can be found in ISO 13849-1 and ISO 13849-2. After those standards fault exclusion can be based on

- the technical improbability of occurrence of some faults,
- generally accepted technical experience, independent of the considered application;
- technical requirements related to the application and the specific hazard.

Note 2 to entry: Failure modes, identified in the devices performing the safety function, can be excluded because their related dangerous failure rate(s) are very low compared to the target failure measure for the safety function under consideration. That is, the sum of the dangerous failure rates of all serial devices on which fault exclusion is being claimed, generally cannot exceed more than 1 % of the target failure measure.

**3.2.21****fault tolerance**

ability of a functional item to continue to perform a required function in the presence of faults or errors

**3.2.22**  
**final element**

part of the BPCS or SIS that implements the physical action necessary to achieve or maintain a safe state

Note 1 to entry: Examples are valves, switch gear, and motors, including their auxiliary elements (such as solenoid valve and actuator used to operate a valve).

**3.2.23**  
**functional safety**

part of the overall safety relating to the process and the BPCS which depends on the correct functioning of the SIS and other protection layers

**3.2.24**  
**functional safety assessment**  
**FSA**

investigation, based on evidence, to judge the functional safety achieved by one or more SIS and/or other protection layers

**3.2.25**  
**functional safety audit**

systematic and independent examination to determine whether the procedures specific to the functional safety requirements comply with the planned arrangements, are implemented effectively and are suitable to achieve the specified objectives

Note 1 to entry: A functional safety audit may be carried out as part of a FSA.

**3.2.26**  
**hardware safety integrity**

part of the safety integrity of the SIS relating to random hardware failures in a dangerous mode of failure

Note 1 to entry: The two failure measures that are relevant in this context are the average frequency of dangerous failure (continuous mode of operation) and the average probability of failure on demand (demand mode of operation).

Note 2 to entry: See 3.2.82.

Note 3 to entry: This definition deviates from the definition in IEC 61508-4:2010 to reflect differences in process sector terminology.

**3.2.27**  
**harm**

injury or damage to the health of people, or damage to property or to the environment

[SOURCE: ISO/IEC Guide 51:2014, 3.1]

**3.2.27.1**  
**harmful event**

hazardous event which has caused harm

Note 1 to entry: Whether or not a hazardous event results in harm depends on whether people, property, or the environment are exposed to the hazardous situation and, in the case of harm to people, whether any such exposed people can escape the consequences of the event after it has occurred. A hazardous event which has caused harm is termed a harmful event.

**3.2.28**  
**hazard**

potential source of harm

Note 1 to entry: The term includes danger to persons arising within a short time scale (e.g., fire and explosion) and also those that have a long-term effect on a person's health (e.g., release of a toxic substance or radioactivity).

[SOURCE: ISO/IEC Guide 51:2014, 3.2, modified – Note 1 to entry has been added]

### **3.2.28.1**

#### **hazardous event**

event that can cause harm

Note 1 to entry: Whether or not a hazardous event results in harm depends on whether people, property or the environment are exposed to the hazardous situation and, in the case of harm to people, whether any such exposed people can escape the consequences of the event after it has occurred.

[SOURCE: ISO/IEC Guide 51:2014: 3.3, modified – see Note 1]

### **3.2.28.2**

#### **hazardous situation**

circumstance in which people, property or the environment are exposed to one or more hazards

[SOURCE: ISO/IEC Guide 51:2014, 3.4]

### **3.2.29**

#### **human error**

intended or unintended human action or inaction that produces an inappropriate result

Note 1 to entry: Mistakes, slips, and lapses are examples of human errors.

Note 2 to entry: This excludes malicious action.

### **3.2.30**

#### **impact analysis**

activity of determining the effect that a change to a function or component will have to other functions or components in the system as well as in other systems

### **3.2.31**

#### **independent organization**

organization that is separate and distinct, by management and other resources, from the organizations responsible for the activities that take place during the specific phase of the SIS safety life-cycle that is subject to the FSA or validation

### **3.2.32**

#### **independent person**

person who is separate and distinct from the activities which take place during the specific phase of the SIS safety life-cycle that is subject to the FSA or validation and does not have direct responsibility for those activities

### **3.2.33**

#### **input function**

function which monitors the process and its associated equipment in order to provide input information for the logic solver

Note 1 to entry: An input function could be a manual function.

### **3.2.34**

#### **instrument**

apparatus used in performing an action (typically found in instrumented systems)

#### **3.2.34.1**

##### **instrumented system**

system composed of sensors (e.g., pressure, flow, temperature transmitters), logic solvers (e.g., programmable controllers, distributed control systems, discrete controllers), and final elements (e.g., control valves, motor control circuits)

Note 1 to entry: Instrumented systems perform instrumented functions including control, monitoring, alarm and protective functions. Instrumented systems can be SIS (see 3.2.67) or BPCS (see 3.2.3).

### **3.2.35 logic function**

function which performs the transformations between input information (provided by one or more input functions) and output information (used by one or more output functions)

Note 1 to entry: Logic functions provide the transformation from one or more input functions to one or more output functions.

Note 2 to entry: For further guidance, see IEC 61131-3:2012 and IEC 60617-12:1997.

### **3.2.36 logic solver**

part of either a BPCS or SIS that performs one or more logic function(s)

Note 1 to entry: In IEC 61511 the following terms for logic solvers are used:

- electrical logic systems for electro-mechanical technology;
- electronic logic systems for electronic technology;
- PE logic system for programmable electronic systems.

Note 2 to entry: Examples are: electrical systems, electronic systems, programmable electronic systems, pneumatic systems, and hydraulic systems. Sensors and final elements are not part of the logic solver.

#### **3.2.36.1 safety configured PE logic solver**

general purpose industrial grade PE logic solver which is specifically configured for use in safety applications

Note 1 to entry: Further guidance can be found in 11.5.

### **3.2.37 maintenance/engineering interface**

hardware and software provided to allow proper SIS maintenance or modification

Note 1 to entry: Maintenance/engineering interface can include instructions and diagnostics which may be found in software, programming terminals with appropriate communication protocols, diagnostic tools, indicators, bypass devices, test devices, and calibration devices.

#### **3.2.37.1 mean repair time MRT**

expected overall repair time

Note 1 to entry: MRT encompasses the times (b), (c) and (d) of the times for MTTR (see 3.2.37.2).

#### **3.2.37.2 mean time to restoration MTTR**

expected time to achieve restoration

Note 1 to entry: MTTR encompasses:

- the time to detect the failure (a);
- the time spent before starting the repair (b);
- the effective time to repair (c);
- the time before the component is put back into operation (d).

The start time for (b) is the end of (a); the start time for (c) is the end of (b); the start time for (d) is the end of (c).

### **3.2.37.3** **maximum permitted repair time** **MPRT**

maximum duration allowed to repair a fault after it has been detected

Note 1 to entry: The MRT may be used as MPRT but the MPRT may be defined without regards to the MRT:

- A MPRT smaller than the MRT can be chosen to decrease the probability of hazardous event.
- A MPRT greater than the MRT can be chosen if the probability of hazardous event can be relaxed.

Note 2 to entry: When a MPRT has been defined it can be used in place of the MRT for calculating the probability of random hardware failures.

### **3.2.38** **mitigation**

action that reduces the consequence(s) of a hazardous event

Note 1 to entry: Examples include emergency depressurization or closing ventilation dampers on detection or confirmed fire or gas leak or initiation of deluge on confirmed fire detection.

### **3.2.39** **mode of operation (of a SIF)**

way in which a SIF operates which may be either low demand mode, high demand mode or continuous mode

- a) **low demand mode:** mode of operation where the SIF is only performed on demand, in order to transfer the process into a specified safe state, and where the frequency of demands is no greater than one per year.
- b) **high demand mode:** mode of operation where the SIF, is only performed on demand, in order to transfer the process into a specified safe state, and where the frequency of demands is greater than one per year.
- c) **continuous mode:** mode of operation where the SIF retains the process in a safe state as part of normal operation.

#### **3.2.39.1** **demand mode SIF**

SIF operating in low demand mode (3.2.39 a)) or high demand mode (3.2.39 b))

Note 1 to entry: In the event of a dangerous failure of the SIF, a hazardous event can only occur

- if the failure is undetected and a demand occurs before the next proof test;
- if the failure is detected by the diagnostic tests but the related process and its associated equipment has not been moved to a safe state before a demand occurs.

Note 2 to entry: The safety integrity levels for SIF operating in demand mode are defined in Tables 4 and 5.

#### **3.2.39.2** **continuous mode SIF**

SIF operating in continuous mode (3.2.39 c))

Note 1 to entry: In the event of a dangerous failure of the SIF a hazardous event will occur without further failure unless action is taken to prevent it within the process safety time.

Note 2 to entry: Continuous mode covers those SIF which implement continuous control to maintain functional safety.

Note 3 to entry: The safety integrity levels for SIF operating in continuous mode are defined in Table 5.

### **3.2.40** **module**

self-contained part of a SIS application program (can be internal to a program or a set of programs) that performs a specified function (e.g., final element start/stop/test sequence, an application specific sequence within a SIF)

Note 1 to entry: In the context of IEC 61131-3:2012, a software module is a function or function block.

Note 2 to entry: Most modules have repetitive usage within an application program.

### 3.2.41

#### **MooN**

SIS, or part thereof, made up of “*N*” independent channels, which are so connected, that “*M*” channels are sufficient to perform the SIF

### 3.2.42

#### **necessary risk reduction**

risk reduction to be achieved by the SIS(s) and/or other protection layers to ensure that the tolerable risk is not exceeded

### 3.2.43

#### **non-programmable system (NP) system**

system based on non-computer technologies (i.e., a system not based on programmable electronics [PE] or software)

Note 1 to entry: Examples would include hard-wired electrical or electronic systems, mechanical, hydraulic, or pneumatic systems.

### 3.2.44

#### **operating environment**

conditions inherent to the installation of a device that potentially affects its functionality and safety integrity, such as:

- external environment, e.g. , winterization needs, hazardous area classification;
- process operating conditions, e.g., extremes in temperature, pressure, vibration;
- process composition, e.g., solids, salts, or corrosives;
- process interfaces;
- integration within the overall plant maintenance and operating management systems;
- communication through-put, e.g., electro-magnetic interference; and
- utility quality, e.g., electrical power, air, hydraulics.

Note 1 to entry: Some process applications may have special operating environment requirements necessary to survive a major accident event. For example some equipment requires special enclosures, purging, or fire protection.

### 3.2.45

#### **operating mode**

#### **process operating mode**

any planned state of process operation, including modes such as start-up after emergency shutdown, normal start-up, operation, and shutdown, temporary operations, and emergency operation and shutdown

### 3.2.46

#### **operator interface**

means by which information is communicated between a human operator and the SIS (e.g., display interfaces, indicating lights, push-buttons, horns, alarms)

Note 1 to entry: The operator interface is sometimes referred to as the human-machine interface (HMI).

### 3.2.47

#### **output function**

function which controls the process and its associated equipment according to output information from the logic function



**3.2.48**  
**performance**

accomplishment of a given action or task measured against the specification and the IEC 61511 series

**3.2.49**  
**phase**

period within the SIS safety life-cycle where activities described in the IEC 61511 series take place

**3.2.50**  
**prevention**

action that reduces the likelihood of occurrence of a hazardous event

**3.2.51**  
**prior use**

documented assessment by a user that a device is suitable for use in a SIS and can meet the required functional and safety integrity requirements, based on previous operating experience in similar operating environments

Note 1 to entry: To qualify a SIS device on the basis of prior use, the user can document that the device has achieved satisfactory performance in a similar operating environment. Understanding how the equipment behaves in the operating environment is necessary to achieve a high degree of certainty that the planned design, inspection, testing, maintenance, and operational practices are sufficient.

Note 2 to entry: Proven in use is based on the manufacturer's design basis (e.g., temperature limit, vibration limit, corrosion limit, desired maintenance support) for his device. Prior use deals with device's installed performance within a process sector application in a specific operating environment which is often different than the manufacturer's design basis.

**3.2.52**  
**process risk**

risk arising from the process conditions caused by abnormal events (including BPCS malfunction)

Note 1 to entry: The risk in this context is that associated with the specific hazardous event in which SIS are to be used to provide the necessary risk reduction (i.e., the risk associated with functional safety).

Note 2 to entry: Process risk analysis is described in IEC 61511-3:2016. The main purpose of determining the process risk is to establish a reference point for the risk without taking into account the protection layers.

Note 3 to entry: Assessment of this risk can include associated human factor issues.

Note 4 to entry: This term equates to "EUC risk" in IEC 61508-4:2010.

**3.2.52.1**  
**process safety time**

time period between a failure occurring in the process or the basic process control system (with the potential to give rise to a hazardous event) and the occurrence of the hazardous event if the SIF is not performed

Note 1 to entry: This is a property of the process only. The SIF has to detect the failure and complete its action soon enough to prevent the hazardous event taking into account any process lag (e.g. cooling of a vessel).

**3.2.53**  
**programmable electronics**  
**PE**

item based on computer technology which may be comprised of hardware, software, and of input and/or output units

Note 1 to entry: This term covers micro-electronic devices based on one or more central processing units (CPU) together with associated memories. Examples of process sector programmable electronics include:

- smart sensors and final elements;
- programmable electronic logic solvers including:

- programmable controllers;
- programmable logic controllers;
- loop controllers.

**3.2.54  
programmable electronic system  
PES**

system for control, protection or monitoring based on one or more programmable electronic devices, including all devices of the system such as power supplies, sensors and other input devices, data highways and other communication paths, actuators and other output devices (see Figure 5)

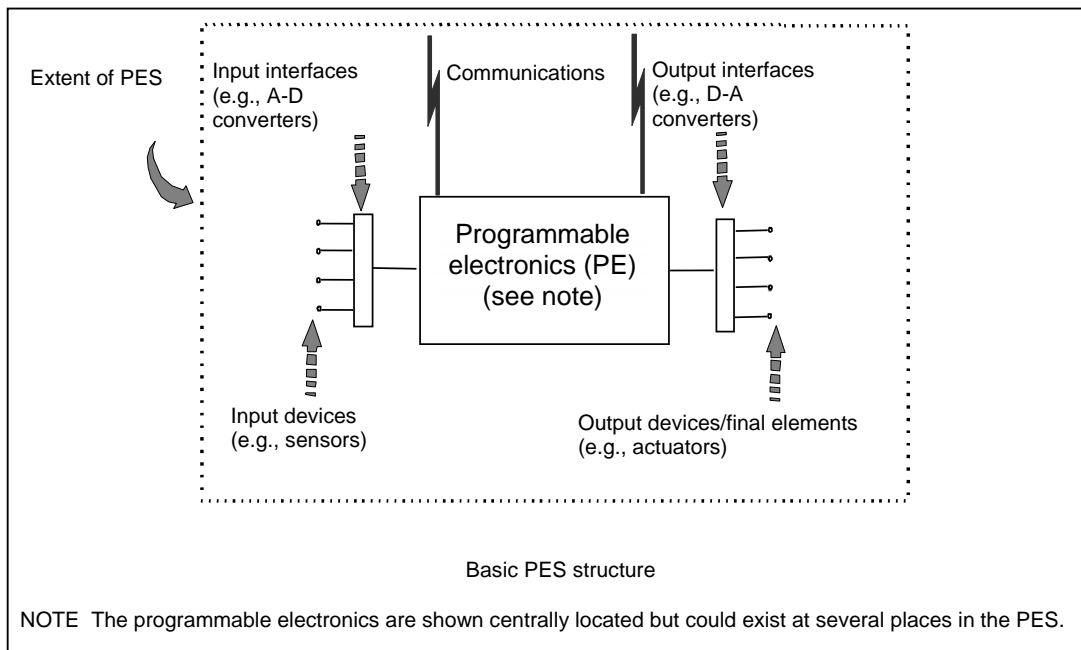

IEC

**Figure 5 – Programmable electronic system (PES): structure and terminology**

**3.2.55  
programming  
coding**

process of designing, writing and testing a set of instructions for solving a problem or processing data

Note 1 to entry: In the IEC 61511 series, programming is typically associated with PE.

**3.2.56  
proof test**

periodic test performed to detect dangerous hidden faults in a SIS so that, if necessary, a repair can restore the system to an ‘as new’ condition or as close as practical to this condition

**3.2.57  
protection layer**

any independent mechanism that reduces risk by control, prevention or mitigation

Note 1 to entry: It can be a process engineering mechanism such as the size of vessels containing hazardous chemicals, a mechanical mechanism such as a relief valve, a SIS or an administrative procedure such as an emergency plan against an imminent hazard. These responses may be automated or initiated by human actions (see Figure 9).

**3.2.58**  
**quality**

totality of characteristics of an entity that bear on its ability to satisfy stated and implied needs

Note 1 to entry: See ISO 9000 for more details.

**3.2.59**  
**random hardware failure**

failure, occurring at a random time, which results from one or more of the possible degradation mechanisms in the hardware

Note 1 to entry: There are many degradation mechanisms occurring at different rates in different components and since manufacturing tolerances cause components to fail due to these mechanisms after different times in operation, failures of a total equipment comprising many components occur at predictable rates but at unpredictable (i.e., random) times.

Note 2 to entry: Two major differences distinguish the random hardware failures and the systematic failures:

- a random hardware failure involves only the system itself while a systematic failure involves both the system itself (a fault) and a particular condition (see 3.2.81). Then a random hardware failure is characterized by a single reliability parameter (i.e., the failure rate) while a systematic failure is characterized by two reliability parameters (i.e., the probability of the pre-existing fault and the hazard rate of the particular condition).
- a systematic failure can be eliminated after being detected while random hardware failures cannot.

This implies that the reliability parameters of random hardware failures can be estimated from field feedback while it is very difficult to do the same for systematic failures. A qualitative approach is preferred for systematic failures.

[SOURCE: IEC 61508-4:2010, 3.6.5, modified – The notes have been changed]

**3.2.60**  
**redundancy**

the existence of more than one means for performing a required function or for representing information

Note 1 to entry: Examples are the use of duplicate devices and the addition of parity bits.

Note 2 to entry: Redundancy is used primarily to improve reliability or availability.

[SOURCE: IEC 61508-4:2010, 3.4.6]

**3.2.61**  
**risk**

combination of the probability of occurrence of harm and the severity of that harm

Note 1 to entry: The probability of occurrence includes the exposure to a hazardous situation, the occurrence of a hazardous event, and the possibility to avoid or limit the harm.

[SOURCE: ISO/IEC Guide 51:2014, 3.8]

**3.2.62**  
**safe failure**

failure which favours a given safety action

Note 1 to entry: A failure is "safe" only with regard to a given safety function.

Note 2 to entry: When fault tolerance is implemented, safe failure can lead to either:

- operation where the safety action is available but with a higher probability of success on demand (demand mode of operation) or a lower likelihood to cause a hazardous event (continuous mode of operation);
- a spurious operation where the safety action is initiated.

Note 3 to entry: When no fault tolerance is implemented, safe failures result in the initiation of the safety action regardless of the process condition. This is also known as a spurious trip.

Note 4 to entry: A spurious trip may be safe with regard to a given safety function but may be dangerous with regard to another safety function.

Note 5 to entry: Spurious trips may also have detrimental effects on the production availability of the process.

### **3.2.63**

#### **safe state**

state of the process when safety is achieved

Note 1 to entry: Some states are safer than others and in going from a hazardous condition to the final safe state, or in going from the nominal safe condition to a hazardous condition, the process may have to go through a number of intermediate safe-states.

Note 2 to entry: For some situations, a safe state exists only so long as the process is continuously controlled. Such continuous control may be for a short or an indefinite period of time.

Note 3 to entry: A state which is safe with regard to a given safety function may increase the probability of hazardous event with regard to another given safety function. In this case, the maximum allowable average spurious trip frequency (see 10.3.2) for the first function can consider the potential increased risk associated with the other function.

Note 4 to entry: This definition deviates from the definition in IEC 61508-4:2010 to reflect differences in process sector terminology.

### **3.2.64**

#### **safety**

freedom from risk which is not tolerable

Note 1 to entry: According to ISO/IEC Guide 51 the terms "acceptable risk" and "tolerable risk" are considered to be synonymous.

[SOURCE: ISO/IEC Guide 51:2014, 3.14, modified – The note has been added]

### **3.2.65**

#### **safety function**

function to be implemented by one or more protection layers, which is intended to achieve or maintain a safe state for the process, with respect to a specific hazardous event

### **3.2.66**

#### **safety instrumented function**

##### **SIF**

safety function to be implemented by a safety instrumented system (SIS)

Note 1 to entry: A SIF is designed to achieve a required SIL which is determined in relationship with the other protection layers participating to the reduction of the same risk.

### **3.2.67**

#### **safety instrumented system**

##### **SIS**

instrumented system used to implement one or more SIFs

Note 1 to entry: A SIS is composed of any combination of sensor (s), logic solver (s), and final elements(s) (e.g., see Figure 6). It also includes communication and ancillary equipment (e.g., cables, tubing, power supply, impulse lines, heat tracing).

Note 2 to entry: A SIS may include software.

Note 3 to entry: A SIS may include human action as part of a SIF (see ISA TR84.00.04:2015, part 1).

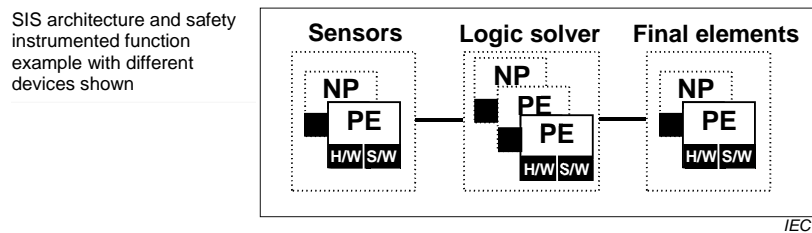

**Figure 6 – Example of SIS architectures comprising three SIS subsystems**

### 3.2.68 safety integrity

ability of the SIS to perform the required SIF as and when required

Note 1 to entry: This definition is equivalent to the dependability of the SIS with regard to the required SIF. Dependability, being often understood as an economical rather than a safety concept, has not been used to avoid confusion.

Note 2 to entry: Ability includes both the functional response (e.g., closing a specified valve within a specified time) and the likelihood that the SIS will act as required.

Note 3 to entry: In determining safety integrity, all causes of random hardware and systematic failures which lead to an unsafe state can be included (e.g., hardware failures, software induced failures and failures due to electrical interferences). Some of these types of failure, in particular random hardware failures, may be quantified using such measures as the average dangerous failure frequency or the probability of failure on demand. However, safety integrity also depends on many systematic factors, which cannot be accurately quantified and are often considered qualitatively throughout the life-cycle. The likelihood that systematic failures result in dangerous failure of the SIS is reduced through hardware fault tolerance (see 11.4) or other methods and techniques.

Note 4 to entry: Safety integrity comprises hardware safety integrity (see 3.2.26) and systematic safety integrity (see 3.2.82), but complex failures caused by the conjunction of both hardware and systematic interaction can also be considered.

### 3.2.69 safety integrity level SIL

discrete level (one out of four) allocated to the SIF for specifying the safety integrity requirements to be achieved by the SIS

Note 1 to entry: The higher the SIL, the lower the expected PFD<sub>avg</sub> for demand mode or the lower the average frequency of a dangerous failure causing a hazardous event for continuous mode.

Note 2 to entry: The relationship between the target failure measure and the SIL is specified in Tables 4 and 5.

Note 3 to entry: SIL 4 is related to the highest level of safety integrity; SIL 1 is related to the lowest

Note 4 to entry: This definition differs from the definition in IEC 61508-4:2010 to reflect differences in process sector terminology.

#### 3.2.69.1 safety integrity requirements, pl

set of the IEC 61511 requirements which shall be satisfied by a SIS to claim a given SIL for a SIF implemented by this SIS

Note 1 to entry: The safety integrity requirements are strengthened when the related SIL increases.

### 3.2.70 SIS safety life-cycle

necessary activities involved in the implementation of SIF occurring during a period of time that starts at the concept phase of a project and finishes when all of the SIF are no longer available for use

Note 1 to entry: The term “functional safety life-cycle” is strictly more accurate, but the adjective “functional” is not considered necessary in this case within the context of the IEC 61511 series.

Note 2 to entry: The SIS safety life-cycle model used in IEC 61511 is shown in Figure 7.

### **3.2.71**

#### **safety manual functional safety manual**

information that defines how a SIS device, subsystem or system can be safely applied

Note 1 to entry: The safety manual may include inputs from the manufacturer as well as from the user.

Note 2 to entry: For IEC 61508 compliant devices, the manufacturer's input is the safety manual,

Note 3 to entry: This could be a generic stand-alone document, or a collection of documents.

Note 4 to entry: This definition deviates from the definition in IEC 61508-4:2010 to reflect differences in process sector terminology.

### **3.2.72**

#### **safety requirements specification SRS**

specification containing the functional requirements for the SIFs and their associated safety integrity levels

[SOURCE: IEC 61508-4:2010, 3.5.11, modified – Aligned with IEC 61511 terminology]

### **3.2.73**

#### **sensor**

part of the BPCS or SIS that measures or detects the process condition

Note 1 to entry: Examples are transmitters, transducers, process switches, and position switches.

### **3.2.74**

#### **software**

programs, procedures, data, rules and any associated documentation pertaining to the operation of a data processing system

Note 1 to entry: Software is independent of the medium on which it is recorded.

Note 2 to entry: For examples of different types of software, see 3.2.75 and 3.2.76.

### **3.2.75**

#### **application programming languages**

#### **3.2.75.1**

##### **fixed program language**

##### **FPL**

language in which the user is limited to adjustment of a few pre-defined and fixed set of parameters

Note 1 to entry: Typical examples of device applications with FPL are: smart sensor (e.g., pressure transmitter without control algorithms), smart final element (e.g. valve without control algorithms), sequence of events recorder, set points for dedicated smart alarm box). The use of FPL is often referred to as "configuration of the device".

#### **3.2.75.2**

##### **limited variability language**

##### **LVL**

programming language for commercial and industrial programmable electronic controllers with a range of capabilities limited to their application as defined by the associated safety manual

Note 1 to entry: This type of language is designed to be easily understood by process sector users, and provides the capability to combine predefined, application specific, library functions to implement the SRS. LVL provides a close functional correspondence with the functions required to achieve the application.

Note 2 to entry: The notation of this language may be textual or graphical or have characteristics of both.

Note 3 to entry: LVL is the most commonly used language when the IEC 61511 series refers to “application program”.

### **3.2.75.3 full variability language**

#### **FVL**

language designed to be comprehensible to computer programmers and that provides the capability to implement a wide variety of functions and applications

Note 1 to entry: Typical example of systems using FVL are general purpose computers.

Note 2 to entry: In the process sector, FVL is found in embedded software and rarely in application programming.

Note 3 to entry: FVL examples include: Ada, C, Pascal, Instruction List, assembler languages, C++, Java, SQL.

### **3.2.76 software & program types**

#### **3.2.76.1 application program**

program specific to the user application containing, in general, logic sequences, permissives, limits and expressions that control the input, output, calculations, and decisions necessary to meet the SIS functional requirements

#### **3.2.76.2 embedded software**

software that is part of the system supplied by the manufacturer and is not accessible for modification by the end-user

Note 1 to entry: Embedded software is also referred to as firmware or system software. See 3.2.75.3 full variability language.

#### **3.2.76.3 utility software**

software tools for the creation, modification, and documentation of application programs

Note 1 to entry: These software tools are not required for the operation of the SIS.

#### **3.2.77 application program life-cycle**

activities occurring during a period of time that starts when the application program is conceived and ends when the application program is permanently disused

Note 1 to entry: An application program life-cycle typically includes a requirements phase, development phase, test phase, integration phase, installation phase and modification phase.

Note 2 to entry: Software, including application program, cannot be maintained; rather, it is modified.

#### **3.2.78 SIS subsystem**

independent part of a SIS whose disabling dangerous failure results in a disabling dangerous failure of the SIS

Note 1 to entry: Figure 6 illustrates a SIS made of three SIS subsystems.

Note 2 to entry: From the cut set approach point of view (see IEC 61025) a minimal cut set of a SIS subsystem is also a minimal cut set of the whole SIS. Therefore the SIFs implemented within a SIS are entirely dependent on the SIS subsystems of this SIS (i.e., when a SIS subsystem fails, the related SIFs also fail).

**3.2.79  
system**

set of devices, which interact according to a specification

Note 1 to entry: A person can be part of a system.

Note 2 to entry: This definition deviates from the definition in IEC 61508 to reflect differences in process sector terminology.

**3.2.80  
systematic capability**

measure (expressed on a scale of SC 1 to SC 4) of the confidence that the systematic safety integrity of a device meets the requirements of the specified SIL, in respect of the specified safety function, when the device is applied in accordance with the instructions specified in the device safety manual

Note 1 to entry: Systematic capability is determined with reference to the requirements for the avoidance and control of systematic faults in IEC 61508-2:2010 and IEC 61508-3:2010.

Note 2 to entry: The systematic failure mechanism depends on the nature of the device. For a device comprised solely of hardware, only hardware failure mechanisms are considered. For a device comprised of hardware and software, it is necessary to consider the interactions between hardware and software failure mechanisms.

Note 3 to entry: A systematic capability of SC N for a device means that the systematic safety integrity of SC N has been met when the device is applied in accordance with the instructions specified in the device safety manual for SC N.

**3.2.81  
systematic failure**

failure related to a pre-existing fault, which consistently occurs under particular conditions, and which can only be eliminated by removing the fault by a modification of the design, manufacturing process, operating procedures, documentation or other relevant factors

Note 1 to entry: The cause of systematic failures of the software may be known as "bugs".

Note 2 to entry: Corrective maintenance without modification would usually not eliminate the failure cause which involves the failure under particular conditions.

Note 3 to entry: A systematic failure can be reproduced by deliberately applying the same conditions, although not all reproducible failures are systematic.

Note 4 to entry: Examples of faults leading to systematic failure include human error that originates in:

- the SRS;
- the design, manufacture, installation, operation or maintenance of the hardware;
- the design or implementation of software (including application program).

Note 5 to entry: Similar devices designed, installed, operated, implemented or maintained in the same way are likely to contain the same faults. Therefore they are subject to common cause failures when the particular conditions occur.

**3.2.82  
systematic safety integrity**

part of the safety integrity of the SIS relating to systematic failures in a dangerous mode of failure

Note 1 to entry: Systematic safety integrity cannot usually be quantified (as distinct from hardware safety integrity).

Note 2 to entry: See 3.2.26 also.

**3.2.83  
target failure measure**

performance required from the SIF and specified in terms of either the average probability of failure to perform the SIF on demand for demand mode of operation or the average frequency of a dangerous failure for continuous mode of operation



Note 1 to entry: The relationship between the target failure measures and the SIL are given in Tables 4 and 5.

### **3.2.84**

#### **tolerable risk**

level of risk which is accepted in a given context based on the current values of society

Note 1 to entry: See IEC 61511-3:2016, Annex A.

[SOURCE: ISO/IEC Guide 51:2014, 3.15]

### **3.2.85**

#### **undetected**

#### **unrevealed**

#### **covert**

not detected or not revealed or not overt

Note 1 to entry: In IEC 61511 and except when the context suggests another meaning, the term “dangerous undetected failures/faults” is related to dangerous failures/faults not detected by diagnostic tests.

### **3.2.86**

#### **validation**

confirmation by examination and provision of objective evidence that the particular requirements for a specific intended use are fulfilled

Note 1 to entry: In the IEC 61511 series this means demonstrating that the SIF(s) and SIS after installation meet the SRS in all respects.

### **3.2.87**

#### **verification**

confirmation by examination and provision of objective evidence that the requirements have been fulfilled

Note 1 to entry: In the IEC 61511 series this is the activity of demonstrating for each phase of the relevant SIS safety life-cycle by analysis and/or tests, that, for specific inputs, the outputs meet in all respects the objectives and requirements set for the specific phase.

Note 2 to entry: Example verification activities include:

- reviews on outputs (documents from all phases of the safety life-cycle) to ensure compliance with the objectives and requirements of the phase taking into account the specific inputs to that phase;
- design reviews;
- tests performed on the designed products to ensure that they perform according to their specification;
- integration tests performed where different parts of a system are put together in a step-by-step manner and by the performance of environmental tests to ensure that all the parts work together in the specified manner.

### **3.2.88**

#### **watchdog**

combination of diagnostics and an output device (typically a switch) for monitoring the correct operation of the programmable electronic (PE) device and taking action upon detection of an incorrect operation

Note 1 to entry: The watchdog confirms that the software system is operating correctly by the regular resetting of an external device (e.g., hardware electronic watchdog timer) by an output device controlled by the software.

Note 2 to entry: The watchdog can be used to de-energize a group of safety outputs when dangerous failures are detected in order to achieve or maintain a safe state of the process with respect to the hazardous event. The watchdog is used to increase the on-line diagnostic coverage of the PE logic solver (see 3.2.13 and 3.2.15).

## **3.3 Abbreviations**

Abbreviations used throughout IEC 61511 are given in Table 1. Also included are some common abbreviations related to process sector functional safety.

**Table 1 – Abbreviations used in IEC 61511**

<b>Abbreviation</b>	<b>Full expression</b>
AC/DC	Alternating current/direct current
AIChE	American Institute of Chemical Engineers
ALARP	As low as reasonably practicable
ANSI	American National Standards Institute
AP	Application program
BPCS	Basic process control system
CCPS	Centre for Chemical Process Safety (AIChE)
DC	Diagnostic coverage
E/E/PE	Electrical/electronic/programmable electronic
EMC	Electro-magnetic compatibility
FAT	Factory acceptance test
FPL	Fixed program language
FSA	Functional safety assessment
FSMS	Functional safety management system
FTA	Fault tree analysis
FVL	Full variability language
HFT	Hardware fault tolerance
H&RA	Hazard & risk assessment
HMI	Human Machine Interface
IEC	International Electrotechnical Commission
ISA	International Society of Automation
ISO	International Organization for Standardization
LVL	Limited variability language
MooN	“M” out of “N” channel architecture
MPRT	Maximum permitted repair time
MRT	Mean repair time
MTTR	Mean time to restoration
NFPA	National Fire Protection Association(US)
NP	Non-programmable
OEM	Original Equipment Manufacturer
PE	Programmable electronics
PES	Programmable electronic system
PFD	Probability of dangerous failure on demand
PFD <sub>avg</sub>	Average probability of dangerous failure on demand
PFH	Probability (average frequency of dangerous failures) of failure per hour
pl	Plural
PLC	Programmable logic controller
SAT	Site acceptance test
SC	Systematic capability
SIF	Safety instrumented function
SIL	Safety integrity level
SIS	Safety instrumented system
SRS	Safety requirement specification

## 4 Conformance to the IEC 61511-1:2016

To conform to the IEC 61511-1:2016, it shall be shown that each of the requirements outlined in Clause 5 through Clause 19 has been satisfied to the defined criteria and therefore the clauses' objectives have been met.

## 5 Management of functional safety

### 5.1 Objective

The objective of the requirements of Clause 5 is to identify the management activities that are necessary to ensure the functional safety objectives are met.

NOTE 1: Clause 5 is solely aimed at the achievement and maintenance of the functional safety of SIS and is separate and distinct from general health and safety measures necessary for the achievement of safety in the workplace.

### 5.2 Requirements

#### 5.2.1 General

The policy and strategy for achieving functional safety shall be identified together with the methods for evaluating their achievement and shall be communicated within the organization.

#### 5.2.2 Organization and resources

**5.2.2.1** Persons, departments, organizations or other units which are responsible for carrying out and reviewing each of the SIS safety life-cycle phases shall be identified and be informed of the responsibilities assigned to them.

**5.2.2.2** Persons, departments or organizations involved in SIS safety life-cycle activities shall be competent to carry out the activities for which they are accountable.

The following items shall be addressed and documented when considering the competence of persons, departments, organizations or other units involved in SIS safety life-cycle activities:

- a) engineering knowledge, training and experience appropriate to the process application;
- b) engineering knowledge, training and experience appropriate to the applicable technology used (e.g., electrical, electronic or programmable electronic);
- c) engineering knowledge, training and experience appropriate to the sensors and final elements;
- d) safety engineering knowledge (e.g., process safety analysis);
- e) knowledge of the legal and regulatory functional safety requirements;
- f) adequate management and leadership skills appropriate to their role in the SIS safety life-cycle activities;
- g) understanding of the potential consequence of an event;
- h) the SIL of the SIF;
- i) the novelty and complexity of the application and the technology.

**5.2.2.3** A procedure shall be in place to manage competence of all those involved in the SIS life cycle. Periodic assessments shall be carried out to document the competence of individuals against the activities they are performing and on change of an individual within a role.

### 5.2.3 Risk evaluation and risk management

Hazards shall be identified, risks evaluated and the necessary risk reduction determined as defined in Clause 8.

NOTE It may be beneficial to consider also potential capital losses, for economic reasons.

### 5.2.4 Safety planning

Safety planning shall take place to define the activities that are required to be carried out along with the persons, departments, organizations or other units responsible to carry out these activities. This planning shall be updated as necessary throughout the entire SIS safety life-cycle (see Clause 6) and carried out to a detailed activity level commensurate with the role the individual or organization is performing in the SIS safety life-cycle.

NOTE The safety planning can be incorporated in

- a section in the quality plan entitled “SIS Safety Life-cycle Plan”; or
- a separate document entitled “SIS Safety Life-cycle Plan”; or
- several documents which may include company procedures or working practices.

### 5.2.5 Implementing and monitoring

**5.2.5.1** Procedures shall be implemented to ensure prompt follow-up and satisfactory resolution of recommendations pertaining to the SIS arising from

- a) hazard analysis and risk assessment;
- b) assurance activities;
- c) verification activities;
- d) validation activities;
- e) FSAs;
- f) functional safety audits;
- g) post-incident and post-accident activities.

**5.2.5.2** Any supplier, providing products or services to an organization that has overall responsibility for one or more phases of the SIS safety life-cycle, shall deliver products or services as specified by that organization and shall have a quality management system. Procedures shall be in place to demonstrate the adequacy of the quality management system.

If a supplier makes any functional safety claims for a product or service, which are used by the organization to demonstrate compliance with the requirements of this part of IEC 61511, the supplier shall have a functional safety management system. Procedures shall be in place to demonstrate the adequacy of the functional safety management system.

The functional safety management system shall meet the requirements of the basic safety standard IEC 61508-1:2010, Clause 6, or the functional safety management requirements of the standard derived from IEC 61508 to which functional safety claims are made.

**5.2.5.3** Procedures shall be implemented to evaluate the performance of the SIS against its safety requirements to:

- identify and prevent systematic failures which could jeopardize safety;
- monitor and assess whether reliability parameters of the SIS are in accordance with those assumed during the design;
- define the necessary corrective action to be taken if the failure rates are greater than what was assumed during design;

- compare the demand rate on the SIF during actual operation with the assumptions made during risk assessment when the SIL requirements were determined.

**5.2.5.4** For existing SIS designed and constructed in accordance with code, standards, or practices prior to the issue of this standard the user shall determine that the equipment is designed, maintained, inspected, tested, and operating in a safe manner.

## **5.2.6 Assessment, auditing and revisions**

### **5.2.6.1 Functional safety assessment (FSA)**

**5.2.6.1.1** A procedure shall be defined and executed for a FSA in such a way that a judgement can be made as to the functional safety and safety integrity achieved by every SIF of the SIS. The procedure shall require that a FSA team be appointed which includes the technical, application and operations expertise needed for the particular application.

**5.2.6.1.2** The membership of the FSA team shall include at least one senior competent person not involved in the project design team (for stages 1, 2 and 3) or not involved in the operation and maintenance of the SIS (for stages 4 and 5).

**5.2.6.1.3** The following shall be considered when planning a FSA:

- the scope of the FSA;
- who is to participate in the FSA;
- the skills, responsibilities and authorities of the FSA team;
- the information that will be generated as a result of any FSA activity;
- the identity of any other safety bodies involved in the FSA;
- the resources required to complete the FSA activity;
- the level of independence of the FSA team;
- the methods by which the FSA will be revalidated after modifications.

NOTE When the FSA team is large; consideration can be given to having more than one senior competent individual on the team who is independent from the project team.

**5.2.6.1.4** A FSA team shall review the work carried out on all phases of the safety life cycle prior to the stage covered by the assessment that have not been already covered by previous FSAs. If previous FSAs have been carried out then the FSA team shall consider the conclusions and recommendations of the previous assessments. The stages in the SIS safety life-cycle at which the FSA activities are to be carried out shall be identified during the safety planning.

NOTE 1 Additional FSA activities can be introduced as new hazards are identified, after modification and at periodic intervals during operation.

NOTE 2 Consideration can be given to carrying out FSA activities at the following stages (see Figure 7).

- Stage 1 – After the H&RA has been carried out, the required protection layers have been identified and the SRS has been developed.
- Stage 2 – After the SIS has been designed.
- Stage 3 – After the installation, pre-commissioning and final validation of the SIS has been completed and operation and maintenance procedures have been developed.
- Stage 4 – After gaining experience in operating and maintenance.
- Stage 5 – After modification and prior to decommissioning of a SIS.

NOTE 3 The number, size and scope of FSA activities can depend upon the specific circumstances. The factors in this decision are likely to include:

- size of project;
- degree of complexity;
- SIL;

- duration of project;
- consequence in the event of failure;
- degree of standardization of design features;
- safety regulatory requirements;
- previous experience with a similar design;
- giving consideration to relevant factors such as:
  - time in operation;
  - number and scope of changes in operation;
  - proof test frequency.

**5.2.6.1.5** Prior to the hazards being present the FSA team shall undertake functional safety assessment(s) and shall confirm:

- the H&RA has been carried out (see 8.1);
- the recommendations arising from the H&RA that apply to the SIS have been implemented or resolved;
- project design change procedures are in place and have been properly implemented;
- the recommendations arising from any FSA have been resolved;
- the SIS is designed, constructed and installed in accordance with the SRS, any differences having been identified and resolved;
- the safety, operating, maintenance and emergency procedures pertaining to the SIS are in place;
- the SIS validation planning is appropriate and the validation activities have been completed;
- the employee training has been completed and appropriate information about the SIS has been provided to the maintenance and operating personnel;
- plans or strategies for implementing further FSAs are in place.

**5.2.6.1.6** Where design, development and production tools are used for any SIS safety life-cycle activity, they shall themselves be subject to an assessment demonstrating that they do not have any negative impact on the SIS or the output of the tools shall be confirmed by verification procedures.

NOTE 1 The degree to which such tools can be addressed will depend upon their impact on the risk level to be achieved.

NOTE 2 Examples of development and production tools include simulation and modelling tools, measuring equipment, test equipment, equipment used during maintenance activities and configuration management tools.

NOTE 3 Quality assurance of tools includes, but is not limited to, traceability to calibration standards, operating history and defect list.

**5.2.6.1.7** The results of the FSA shall be available together with any recommendation coming from this assessment.

**5.2.6.1.8** All relevant information shall be made available to the FSA team upon their request.

**5.2.6.1.9** In cases where a FSA is carried out on a modification the assessment shall consider the impact analysis carried out on the proposed modification and confirm that the modification work performed is in compliance with the requirements of IEC 61511.

NOTE Safety life cycle (including FSA) requirements related to SIS modifications can be found in 17.2.3.

**5.2.6.1.10** A FSA shall also be carried out periodically during the operations and maintenance phase to ensure that maintenance and operation are being carried out according

to the assumptions made during design and that the requirements within IEC 61511 for safety management and verification are being met.

### **5.2.6.2 Functional safety audit and revision**

**5.2.6.2.1** The purpose of the audit is to review information documents and records to determine whether the functional safety management system (FSMS) is in place, up to date, and being followed. Where gaps are identified, recommendations for improvements are made.

**5.2.6.2.2** All procedures identified as necessary resulting from all safety life-cycle activities shall be subject to safety audit.

**5.2.6.2.3** Functional safety audit shall be performed by an independent person not undertaking work on the SIS to be audited. Procedures shall be defined and executed for auditing compliance with requirements including:

- the frequency of the functional safety audit activities;
- the degree of independence between the persons, departments, organizations or other units carrying out the work and those carrying out the functional safety auditing activities;
- the recording and follow-up activities.

**5.2.6.2.4** Management of change procedures shall be in place to initiate, document, review, implement and approve changes to the SIS other than replacement in kind (i.e., like for like, an exact duplicate of an element or an approved substitution that does not require modification to the SIS as installed).

**5.2.6.2.5** Management of change procedures shall be in place that identifies changes that will affect the requirements on the SIS (e.g., re-design of a BPCS, changes to manning in a certain area).

### **5.2.7 SIS configuration management**

**5.2.7.1** Procedures for configuration management of the SIS during any SIS safety life-cycle phase shall be available.

NOTE In particular, the following can be specified:

- the stage at which formal configuration management is to be implemented;
- the procedures to be used for uniquely identifying all components of a SIS or SIS-subsystem (e.g., devices, application programming);
- the procedures for preventing unauthorized devices from entering service.

**5.2.7.2** The SIS software, hardware and procedures used to develop and execute the application program shall be subject to configuration management and shall be maintained under revision control.

NOTE SIS software includes application program (e.g., in logic solvers); embedded software (e.g., sensors, logic solvers, final elements); utility software (tools).

## **6 Safety life-cycle requirements**

### **6.1 Objectives**

The objectives of Clause 6 are:

- to define the phases and establish the requirements of the SIS safety life-cycle activities;
- to define and organize the technical activities into a SIS safety life-cycle;
- to ensure that adequate planning exists (or is developed) that makes certain that the SIS meets the safety requirements.

NOTE 1 The overall approach of the IEC 61511 series is shown in Figure 7. It can be stressed that this approach is for illustration and is only meant to indicate the typical SIS safety life-cycle activities from initial conception through decommissioning.

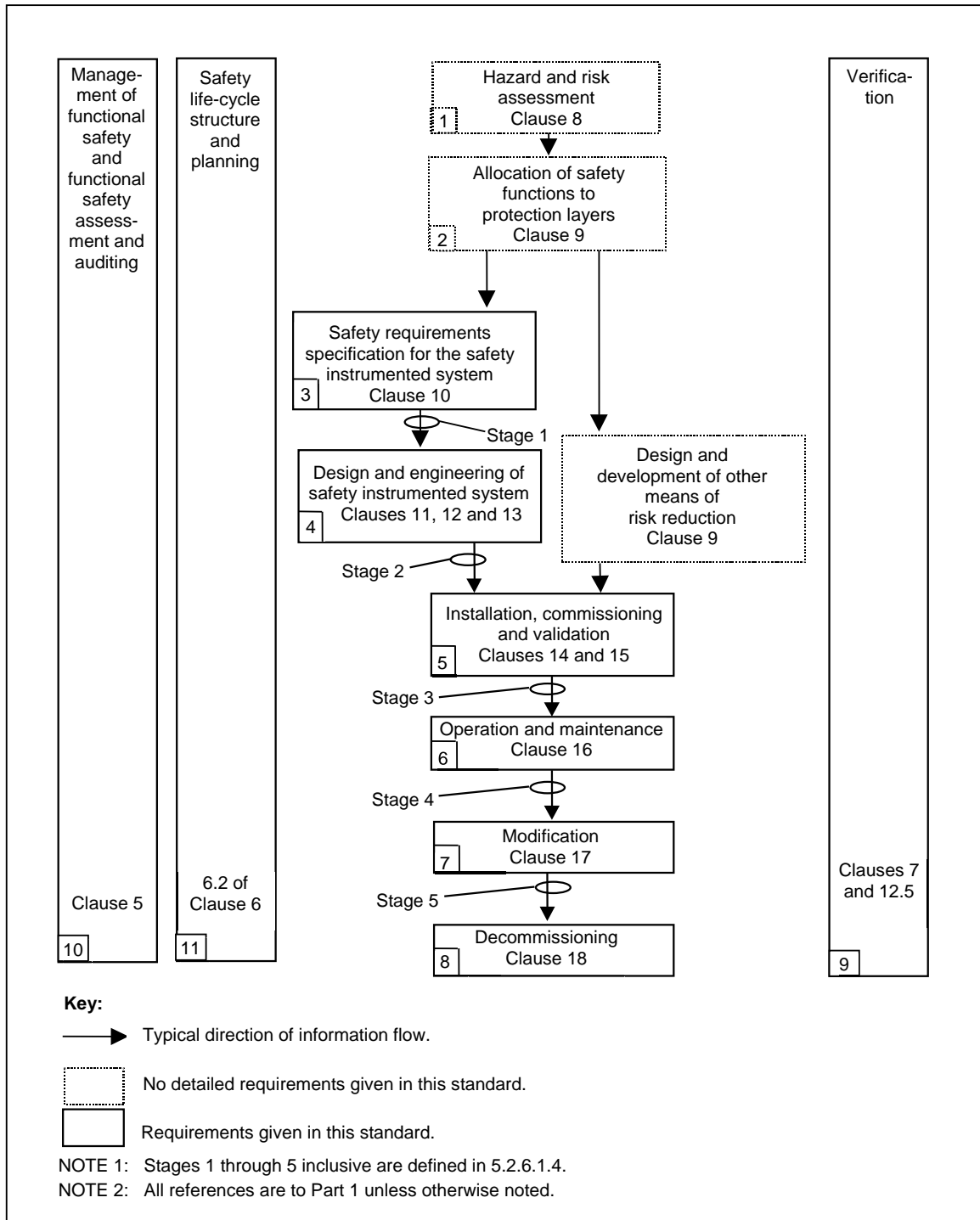

**Figure 7 – SIS safety life-cycle phases and FSA stages**

NOTE 2 Information in Figure 7 may flow from operation and maintenance back to the earlier life-cycle stages to reflect tracking of incidents and failures and to verify engineering assumptions.

## 6.2 Requirements

**6.2.1** A SIS safety life-cycle incorporating the requirements of the IEC 61511 series shall be defined during safety planning. The safety life-cycle shall also address the application programming (see 6.3.1).



**6.2.2** Each phase of the SIS safety life-cycle shall be defined in terms of its inputs, outputs and verification activities (see Table 2).

**Table 2 – SIS safety life-cycle overview (1 of 2)**

Safety life-cycle phase or activity		Objectives	Requirements Clause	Inputs	Outputs
Figure 7 box number	Title				
1	H&RA	To determine the hazards and hazardous events of the process and associated equipment, the sequence of events leading to the hazardous event, the process risks associated with the hazardous event, the requirements for risk reduction and the safety functions required to achieve the necessary risk reduction	Clause 8	Process design, layout, manning arrangements, safety targets	A description of the hazards, of the required safety function(s) and of the associated risk reduction
2	Allocation of safety functions to protection layers	Allocation of safety functions to protection layers and for each SIF, the associated SIL	Clause 9	A description of the required SIF and associated safety integrity requirements	Description of allocation of safety requirements
3	SIS safety requirements specification	To specify the requirements for each SIS, in terms of the required SIF and their associated safety integrity, in order to achieve the required functional safety	Clause 10	Description of allocation of safety requirements	SIS safety requirements; application program safety requirements
4	SIS design and engineering	To design the SIS to meet the requirements for SIF and their associated safety integrity	Clauses 11, 12	SIS safety requirements Application program safety requirements	Design of the SIS hardware and application program in conformance with the SIS safety requirements; planning for the SIS integration test
5	SIS installation commissioning and validation	To integrate and test the SIS  To validate that the SIS meets in all respects the requirements for safety in terms of the required SIF and their associated safety integrity	Clauses 14, 15	SIS design SIS integration test plan SIS safety requirements Plan for the safety validation of the SIS	Fully functioning SIS in conformance with the SIS safety requirements.  Results of SIS integration tests  Results of the installation, commissioning and validation activities

**Table 2 (2 of 2)**

Safety life-cycle phase or activity		Objectives	Requirements Clause	Inputs	Outputs
Figure 7 box number	Title				
6	SIS operation and maintenance	To ensure that the functional safety of the SIS is maintained during operation and maintenance	Clause 16	SIS safety requirements SIS design Plan for SIS operation and maintenance	Results of the operation and maintenance activities
7	SIS modification	To make corrections, enhancements or adaptations to the SIS, ensuring that the required SIL is achieved and maintained	Clause 17	Revised SIS safety requirements	Results of SIS modification
8	Decommissioning	To ensure proper review, sector organization, and ensure SIF remains appropriate	Clause 18	As built safety requirements and process information	SIF placed out of service
9	SIS verification	To test and evaluate the outputs of a given phase to ensure correctness and consistency with respect to the products and standards provided as input to that phase	Clause 7, 12.5	Plan for the verification of the SIS for each phase	Results of the verification of the SIS for each phase
10	SIS FSA	To investigate and arrive at a judgement on the functional safety achieved by the SIS	Clause 5	Planning for SIS FSA SIS safety requirement	Results of SIS FSA
11	Safety lifecycle structure and planning	To establish how the lifecycle steps are accomplished	6.2	Not applicable	Safety plan

**6.2.3** For all SIS safety life-cycle phases, safety planning shall take place to define the activities, criteria, techniques, measures, procedures and responsible organisation/people to:

- ensure that the SIS safety requirements are achieved for all relevant modes of the process; this includes both functional and safety integrity requirements;
- ensure proper installation and commissioning of the SIS;
- ensure the safety integrity of the SIF after installation;
- maintain the safety integrity during operation (e.g., proof testing, failure analysis);
- manage the process hazards during maintenance activities on the SIS.

**6.2.4** If at any stage of the safety life-cycle, a change is required pertaining to an earlier life-cycle phase, then that earlier SIS safety life-cycle phase and the subsequent phases shall be re-examined, altered as required and re-verified.

**6.3 Application program SIS safety life-cycle requirements**

**6.3.1** Each phase of the application program safety life-cycle (see Figure 8) shall be defined in terms of its elementary activities, objectives, required input information and output results and verification requirements (see Table 3).

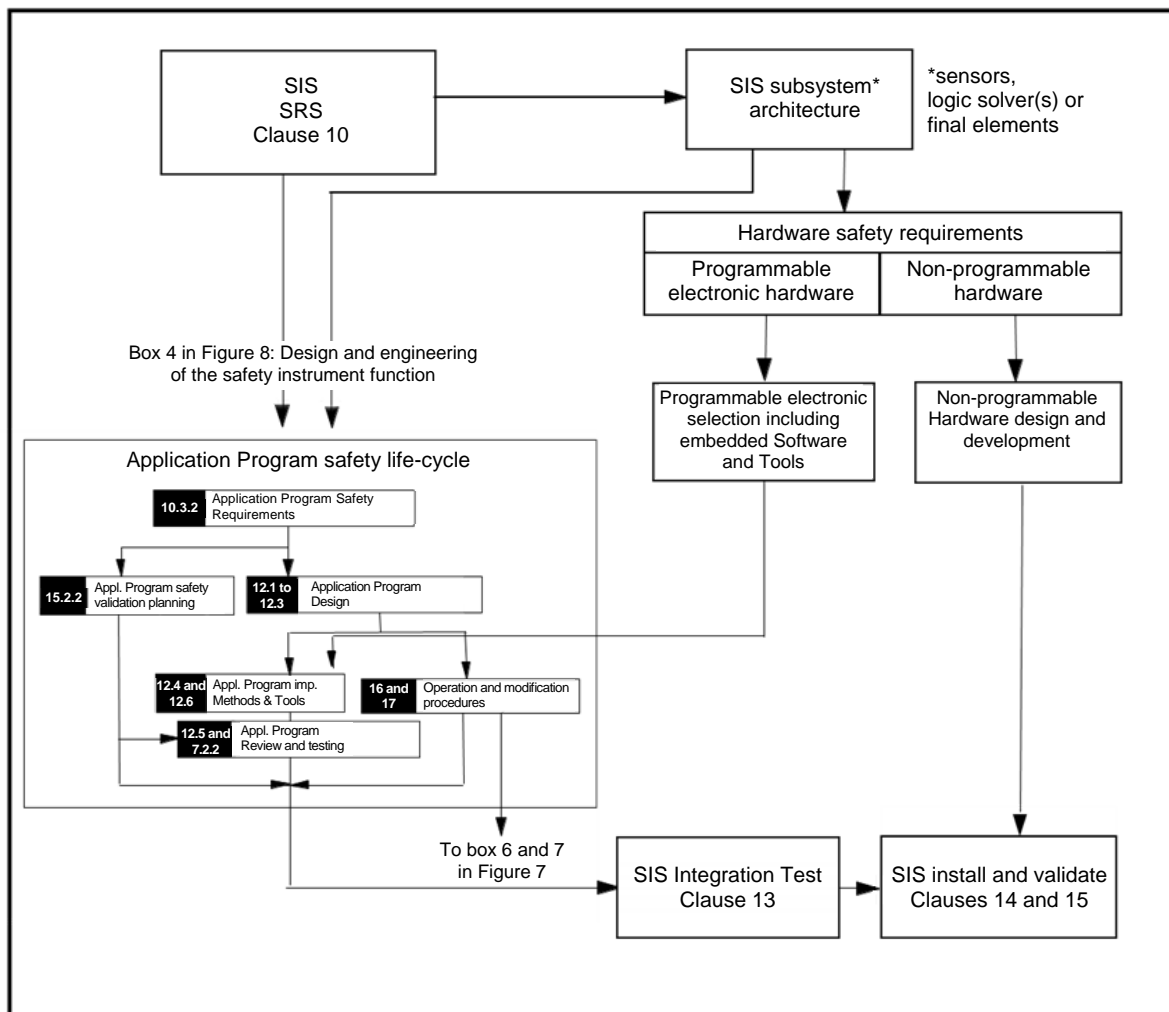

IEC

**Figure 8 – Application program safety life-cycle and its relationship to the SIS safety life-cycle**

**Table 3 – Application program safety life-cycle: overview (1 of 2)**

Safety life-cycle phase		Objectives	Requirements Clause	Inputs	Outputs
Figure 8 box number	Title				
10.3.2	Application program safety requirements	<p>To specify application program safety requirements for each SIS necessary to implement the required SIF.</p> <p>To specify the requirements for application program for each SIF allocated to that SIS.</p>	10.3 11.5	<p>SIS safety requirements.</p> <p>Safety manuals of the selected SIS.</p> <p>SIS architecture.</p>	<p>SIS application program safety requirements specification.</p> <p>Verification information.</p>
15.2.2	Application program safety validation planning	To develop a plan for validating the application program.	15.2.2, 15.2.5	SIS application program safety requirements.	<p>SIS safety validation planning.</p> <p>Verification information.</p>
12.1 to 12.3	Application program development	<p>Architecture.</p> <p>To create an application program architecture that fulfils the specified requirements for application program safety.</p> <p>To review and evaluate the requirements placed on the application program by the hardware architecture of the SIS.</p> <p>To specify the procedures for the development of the application program.</p>	12.1 (also 10.3, 12.2)	<p>SIS application program safety requirements.</p> <p>SIS hardware architecture design constraints.</p>	<p>Description of the architecture design, e.g., segregation of application program into related process sub-system and SIL, e.g., recognition of common application program modules such as pump or valve sequences.</p> <p>Application program architecture and sub-system integration test requirements.</p> <p>Verification information.</p>
	Application program design	<p>To develop the application program design.</p> <p>To identify a suitable set of configuration, library, management, and simulation and test tools, over the safety life-cycle of the application program.</p>	12.3	<p>SIS application program safety requirements.</p> <p>Description of the architecture design.</p> <p>Manuals of the SIS.</p> <p>Safety Manual of the selected SIS logic solver.</p>	<p>Application program design.</p> <p>Procedures for use during programming.</p> <p>Description of the standard (manufacturers) library functions to be used.</p> <p>Verification information.</p>

**Table 3 (2 of 2)**

Safety life-cycle phase		Objectives	Requirements Clause	Inputs	Outputs
Figure 8 box number	Title				
12.4 12.6	Application program implementation	Application development and application module development.  To implement the application program that fulfils the specified requirements for application safety.  To use appropriate support tools and programming languages.	12.4 12.3.4 12.6	Description of the design.  List of manuals and procedures of the selected logic solver for use with the application program.	Application program (e.g., function block diagrams, ladder logic).  Application program simulation and integration test.  Special purpose application program safety requirements.  Verification information.
12.5 7.2.2	Application program verification	To verify that the requirements for application program safety have been achieved.  To show that all SIS application programs interact correctly to perform their intended functions and do not perform unintended functions.	12.5 7.2.2	Application program simulation and integration test requirements (structure based testing).  Application program architecture integration test requirements.	Application program test results.  Verified and tested application program system.  Verification information.
13	SIS integration test	To integrate the application program onto the target logic solver, including interaction with a sample set of field devices and or simulator.	Clause 13	Application program and logic solver integration test requirements.	Application program and logic solver integration test results.

**6.3.2** Methods, techniques and tools shall be applied for each life-cycle phase in accordance with 12.6.2.

**6.3.3** Each phase of the SIS safety life-cycle for which safety planning has been carried out shall be verified (see Clause 7) and the results shall be available as described in Clause 19.

## 7 Verification

### 7.1 Objective

The objective of Clause 7 is to demonstrate by review, analysis and/or testing that the required outputs satisfy the defined requirements for the appropriate phases (Figure 7) as identified by the verification planning.

### 7.2 Requirements

**7.2.1** Verification planning shall be carried out throughout the SIS safety life-cycle and shall define all activities required for the appropriate phase (Figure 7) of the safety life-cycle, including the application program. Verification planning shall conform to the IEC 61511 series by addressing the following:

- the verification activities;

- the procedures, measures and techniques to be used for verification including implementation and resolution of resulting recommendations;
- when these activities will take place;
- the persons, departments and organizations responsible for these activities, including levels of independence;
- identification of items to be verified;
- identification of the information against which the verification is carried out;
- the adequacy of the outputs against the requirements for that phase;
- correctness of the data;
- how to handle non-conformances;
- tools and supporting analysis;
- the completeness of the SIS implementation and the traceability of the requirements;
- the readability and audit-ability of the documentation;
- the testability of the design.

**7.2.2** Where the verification includes testing, the verification planning shall also address the following:

- the strategy for integration of application program and hardware and field devices, including the integration of sub-systems that shall comply with other standards (such as machinery or burner);
- test scope (describes the test set-up and what type of test to be performed including the hardware, application programming, and programming devices to be included);
- test cases and test data (these will be specific scenarios with the associated data);
- types of tests to be performed;
- test environment including tools, hardware, all software and required configuration;
- test criteria (e.g., pass/fail criteria) on which the results of the test will be evaluated;
- procedures for corrective action on failure during test;
- physical location(s) (e.g., factory or site);
- dependence on external functionality;
- appropriate personnel;
- management of change;
- non-conformances.

**7.2.3** Non-safety functions integrated with safety functions shall be verified for non-interference with the safety functions.

**7.2.4** Verification shall be performed according to the verification planning.

**7.2.5** During testing, any modification shall be subjected to an impact analysis which shall determine all SIS components impacted and the necessary re-verification activities.

**7.2.6** The results of the verification process shall be available (see Clause 19), including whether the objective and criteria of the tests have been met.

NOTE 1 Selection of techniques and measures for the verification process and the degree of independence depends upon a number of factors including degree of complexity, novelty of design, novelty of technology and required SIL.

NOTE 2 Examples of some verification activities include design reviews, use of tools and techniques including software verification tools and computer based design analysis tools.

## 8 Process H&RA

### 8.1 Objectives

The objectives of the requirements of Clause 8 are to determine:

- the hazards and hazardous events of the process and associated equipment;
- the sequence of events leading to the hazardous event;
- the process risks associated with the hazardous event;
- any requirements for risk reduction;
- the safety functions required to achieve the necessary risk reduction;
- if any of the safety functions are SIFs.

NOTE 1 Clause 8 addresses process engineers, hazard and risk specialists, safety managers as well as instrument engineers. Its purpose is to recognize the multi-disciplinary approach typically required for the determination of SIF.

NOTE 2 Where reasonably practicable, processes can be designed to be inherently safe. When this is not practicable, other layers of protection (see Figure 9) can be required. In some applications, industry standards can specify the use of particular protection layers.

NOTE 3 The risk reduction can be accomplished using several layers of protection and the layers can be independent, sufficient, dependable and auditable.

### 8.2 Requirements

**8.2.1** A H&RA shall be carried out on the materials, process and equipment. It shall result in:

- a description of each identified hazardous event and the factors that contribute to it;
- a description of the likelihood and consequence of each hazardous event;
- consideration of process operating modes such as normal operation, start-up, shutdown, maintenance, process upset, and emergency shutdown;
- the determination of additional risk reduction necessary to achieve the required functional safety;
- a description of, or references to information on, the measures taken to reduce or remove hazards and risk;
- a detailed description of the assumptions made during the analysis of the risks including demand rates on the protection layers and the average frequency of dangerous failures of the initiating sources, and of any credit taken for operational constraints or human intervention;
- identification of those safety function(s) applied as SIF(s).

NOTE 1 In determining the safety integrity requirements, account can be taken of the effects of common cause between systems that create demands and the protection layers that are designed to respond to those demands. An example of this would be where demands can arise through BPCS failure and the equipment used within the protective layers is similar or identical to the equipment used within the BPCS. In such cases, a demand caused by a failure of BPCS equipment may not be responded to effectively if a common cause has rendered similar equipment in the protection layer to be ineffective. It may not be possible to recognize common cause problems during the initial hazard identification and risk analysis because at such an early stage the design of the protection layers will not necessarily have been completed. In such cases, it can be necessary to reconsider the safety integrity requirements and SIF once the design of the SIS and other protection layers has been completed. In determining whether the overall design of process and protection layers meets requirements, common cause failures will be considered.

NOTE 2 Examples of techniques that can be used to establish the required SILs of SIFs are illustrated in IEC 61511-3:2016.

**8.2.2** The average frequency of dangerous failures of a BPCS as an initiating source shall not be assumed to be  $<10^{-5}$  per hour.

**8.2.3** The H&RA shall be recorded in such a way that the relationship between the above items is clear and traceable.

NOTE 1 The above requirements do not mandate that the safety integrity requirements have to be assigned as numerical values. Qualitative or semi-quantitative approaches (see IEC 61511-3:2016, Annexes C, D & E) can also be used.

NOTE 2 The safety integrity requirements vary depending on the application and national legal requirements. An accepted principle in many countries is that additional risk reduction measures can be applied until the cost incurred becomes disproportionate to the improvement in safety integrity achieved.

**8.2.4** A security risk assessment shall be carried out to identify the security vulnerabilities of the SIS. It shall result in:

- a description of the devices covered by this risk assessment (e.g., SIS, BPCS or any other device connected to the SIS);
- a description of identified threats that could exploit vulnerabilities and result in security events (including intentional attacks on the hardware, application programs and related software, as well as unintended events resulting from human error);
- a description of the potential consequences resulting from the security events and the likelihood of these events occurring;
- consideration of various phases such as design, implementation, commissioning, operation, and maintenance;
- the determination of requirements for additional risk reduction;
- a description of, or references to information on, the measures taken to reduce or remove the threats.

NOTE 1 Guidance related to SIS security is provided in ISA TR84.00.09, ISO/IEC 27001:2013, and IEC 62443-2-1:2010.

NOTE 2 The information and control of boundary conditions needed for the security risk assessment are typically with owner/operating company of a facility, not with the supplier. Where this is the case, the obligation to comply with 8.2.4 can be with the owner/operating company of the facility.

NOTE 3 The SIS security risk assessment can be included in an overall process automation security risk assessment.

NOTE 4 The SIS security risk assessment can range in focus from an individual SIF to all SISs within a company.

## **9 Allocation of safety functions to protection layers**

### **9.1 Objectives**

The objectives of the requirements of Clause 9 are to

- allocate safety functions to protection layers;
- determine the required SIFs;
- determine for each SIF the associated safety integrity requirements.

NOTE 1 Account can be taken, during the process of allocation, of other industry standards or codes.

NOTE 2 The integrity requirements for each SIF might include the associated risk reduction, PFD, PFH or SIL.

### **9.2 Requirements of the allocation process**

#### **9.2.1** The allocation process shall result in

- the allocation of safety functions required to achieve the necessary risk reduction to specific protection layers;
- the allocation of risk reduction or average frequency of dangerous failure to each SIF.

NOTE Legislative requirements or other industry codes may influence the allocation process.

**9.2.2** The required SIL shall be derived taking into account the required PFD or PFH that is to be provided by the SIF.



NOTE Further guidance can be found in IEC 61511-3:2016.

**9.2.3** For each SIF operating in demand mode, the required SIL shall be specified in accordance with either Table 4 or Table 5.

**9.2.4** For each SIF operating in continuous mode, the required SIL shall be specified in accordance with Table 5.

**Table 4 – Safety integrity requirements:  $PFD_{avg}$**

DEMAND MODE OF OPERATION		
Safety integrity level (SIL)	$PFD_{avg}$	Required risk reduction
4	$\geq 10^{-5}$ to $< 10^{-4}$	$> 10\ 000$ to $\leq 100\ 000$
3	$\geq 10^{-4}$ to $< 10^{-3}$	$> 1\ 000$ to $\leq 10\ 000$
2	$\geq 10^{-3}$ to $< 10^{-2}$	$> 100$ to $\leq 1\ 000$
1	$\geq 10^{-2}$ to $< 10^{-1}$	$> 10$ to $\leq 100$

**Table 5 – Safety integrity requirements: average frequency of dangerous failures of the SIF**

CONTINUOUS MODE OR DEMAND MODE OF OPERATION	
Safety integrity level (SIL)	Average frequency of dangerous failures (failures per hour)
4	$\geq 10^{-9}$ to $< 10^{-8}$
3	$\geq 10^{-8}$ to $< 10^{-7}$
2	$\geq 10^{-7}$ to $< 10^{-6}$
1	$\geq 10^{-6}$ to $< 10^{-5}$

NOTE 1 Further explanation of modes of operation can be found in 3.2.39.

NOTE 2 The SIL is defined numerically so as to provide an objective measure for comparison of alternate designs and solutions. However, it is recognized that, given the current state of knowledge, many systematic causes of failure can only be assessed qualitatively.

NOTE 3 The required average frequency of dangerous failures for a continuous mode SIF is determined by considering the risk caused by failure of the continuous mode SIF together with the failures of other devices that lead to the same risk, taking into consideration the risk reduction provided by other protection layers.

**9.2.5** In cases where the allocation process results in a risk reduction requirement of  $>10\ 000$  or average frequency of dangerous failures  $>10^{-8}$  per hour for a single SIS or multiple SISs or SIS in conjunction with a BPCS protection layer, there shall be a reconsideration of the application (e.g., process, other protection layers) to determine if any of the risk parameters can be modified so that the risk reduction requirement of  $>10\ 000$  or average frequency of dangerous failures  $>10^{-8}$  per hour is avoided. The review shall consider whether:

- the process or vessels/pipe work can be modified to remove or reduce hazards at the source;
- additional safety-related systems or other risk reduction means, not based on instrumentation, can be introduced;
- the severity of the consequence can be reduced, e.g., reducing the amount of hazardous material;
- the likelihood of the specified consequence can be reduced e.g., reducing the likelihood of the initiating source of the hazardous event.

NOTE Applications which require the use of a single SIF with a risk reduction requirement  $>10\ 000$  or average frequency of dangerous failures  $>10^{-8}$  per hour can be avoided because of the difficulty of achieving and

maintaining such high levels of performance throughout the SIS safety life-cycle. Risk reduction requirement  $>10\ 000$  or average frequency of dangerous failures  $>10^{-8}$  per hour can require high levels of competence and high levels of coverage for all factory acceptance testing, proof testing, verification, and validation activities.

**9.2.6** If after further consideration of the application and confirmation that a risk reduction requirement  $>10\ 000$  or average frequency of dangerous failures  $>10^{-8}$  per hour is still required, then consideration should be given to achieving the safety integrity requirement using a number of protection layers (e.g., SIS or BPCS) with lower risk reduction requirements. If the risk reduction is allocated to multiple protection layers then such protection layers shall be independent from each other or the lack of independence shall be assessed and shown to be sufficiently low compared to the risk reduction requirements. The following factors shall be considered during this assessment:

- common cause of failure of SIS and the cause of demand.

NOTE 1 The extent of the common cause can be assessed by considering the diversity of all devices where failure could cause a demand and all devices of the BPCS protection layer and/or the SIS used for risk reduction.

NOTE 2 An example of common cause between the SIS and the cause of demand is if loss of process control through sensor fault or failure can cause a demand and the sensor used for control is of the same type as the sensor used for the SIS.

- common cause of failure with other protection layers providing risk reduction.

NOTE 3 The extent of the common cause can be assessed by considering the diversity of all devices of the BPCS protection layer and/or the SIS used to achieve the risk reduction requirements.

NOTE 4 An example of common cause between SISs providing risk reduction is when two separate and independent SISs with diverse measurements and diverse logic solvers are used but the final actuation devices are two shut off valves of similar types or a single shut off valve actuated by both SISs.

- any dependencies that may be introduced by common operations, maintenance, inspection or test activities or by common proof test procedures and proof test times.

NOTE 5 Even if the protective layers are diverse then synchronous proof testing will reduce the overall risk reduction achieved and this can be a significant factor impeding achievement of the necessary risk reduction for the hazardous event.

NOTE 6 When high levels of risk reduction are required and proof tests are desynchronised according to Note 5 then the dominant factor is normally common cause failure even if multiple independent protection layers are used to reduce risk. Dependency within and between protection layers providing risk reduction for the same hazardous event can be assessed and shown to be sufficiently low.

**9.2.7** If a risk reduction requirement  $>10\ 000$  or average frequency of dangerous failures  $>10^{-8}$  per hour is to be implemented, whether allocated to a single SIS or multiple SIS or SIS in conjunction with a BPCS protection layer, then a further risk assessment shall be carried out using a quantitative methodology to confirm that the safety integrity requirements are achieved. The methodology shall take into consideration dependency and common cause failures between the SIS and:

- any other protection layer whose failure would place a demand on it;
- any other SIS reducing the likelihood of the hazardous event;
- any other risk reduction means that reduce the likelihood of the hazardous event (e.g., safety alarms).

**9.2.8** If the risk reduction required for a hazardous event is allocated to multiple SIFs in a single SIS, then the SIS shall meet the overall risk reduction requirement.

**9.2.9** The results of the allocation process shall be recorded so that the SIFs are described in terms of the functional needs of the process, e.g., the actions to be taken, set points, reaction times, activation delays, fault treatment, valve closure requirements, and in terms of the risk reduction requirements.

NOTE This description can be in an unambiguous logical form and can be referred to as the process requirements specification or the safety description. The description can make the intent and the approach used in the allocation process clear. The process requirements specification is used as input information for the SRS covered in Clause 10 and can be sufficiently detailed to ensure adequate specification of the SIS and its devices. For example, the description can include the set-points for sensors, the process safety time available for response, and the valve closure requirements.

### 9.3 Requirements on the basic process control system as a protection layer

**9.3.1** The basic process control system may be claimed as a protection layer as shown in Figure 9.

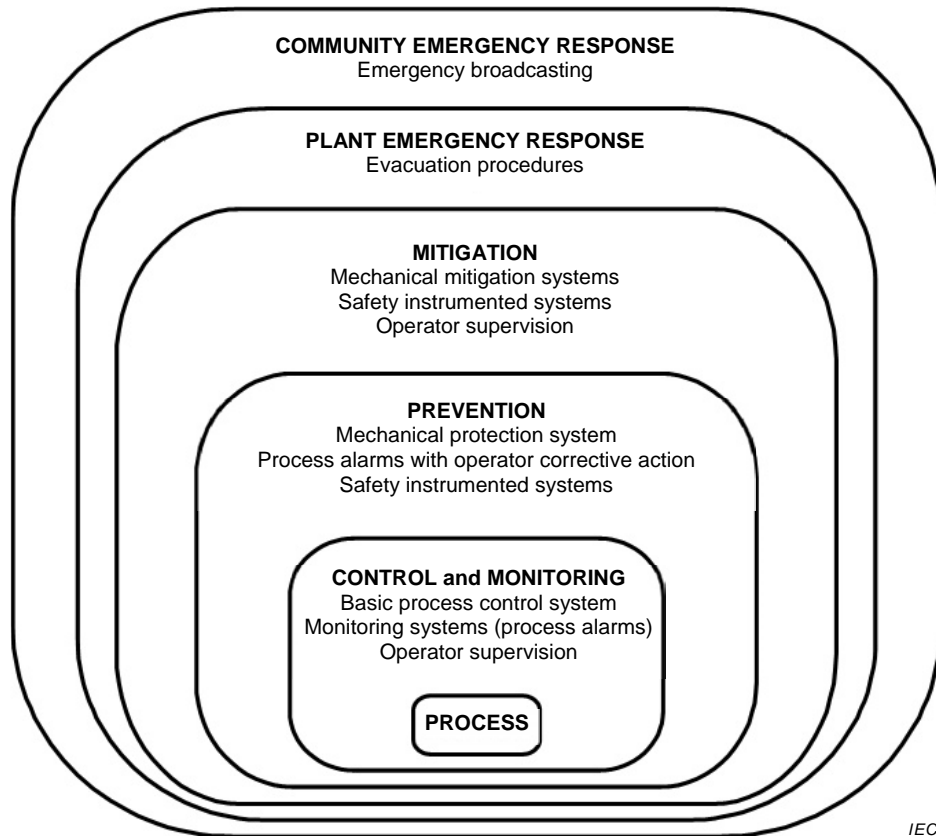

**Figure 9 – Typical protection layers and risk reduction means**

**9.3.2** The risk reduction claimed for a BPCS protection layer shall be  $\leq 10$ .

NOTE Consideration can be given to the fact that a BPCS may also be an initiating source for the demand on the protection layer.

**9.3.3** If the risk reduction claimed for a BPCS protection layer is  $> 10$ , then the BPCS shall be designed and managed to the requirements within the IEC 61511 series.

**9.3.4** If it is not intended that the BPCS conform to the IEC 61511 series, then:

- no more than one BPCS protection layer shall be claimed for the same sequence of event leading to the hazardous event when the BPCS is the initiating source for the demand on the protection layer; or
- no more than two BPCS protection layers shall be claimed for the same sequence of event leading to the hazardous event when the BPCS is not the initiating source of the demand.

NOTE The identified BPCS protection layer can consist of one BPCS as the initiating source for the demand (see 8.2.2) and a second independent BPCS protection layer (see 9.3.2 and 9.3.3) or up to two independent BPCS protection layers when the initiating source is not related to BPCS failure.

**9.3.5** When 9.3.4 applies, each BPCS protection layer shall be independent and separate from the initiating source and from each other to the extent that the claimed risk reduction of each BPCS protection layer is not compromised.

NOTE 1 The assessment of separation and independence can consider what is necessary to achieve the risk reduction, e.g., the central processing units (CPU), input/output modules, relays, field devices, application

programming, networks, program database, engineering tools, human machine interface, by-pass tools and other devices.

NOTE 2 A hot backup controller is not considered to be independent of the primary controller because it is subject to common cause failure (for example, hot backup controllers have components that are common to both the primary and the backup controller, such as the backplane, firmware, diagnostics, transfer mechanisms and undetected dangerous failures).

#### **9.4 Requirements for preventing common cause, common mode and dependent failures**

**9.4.1** The design of the protection layers shall be assessed to ensure that the likelihood of common cause, common mode and dependent failures between:

- protection layers;
- protection layers and the BPCS.

are sufficiently low in comparison to the overall safety integrity requirements of the protection layers. The assessment may be qualitative or quantitative unless 9.2.7 applies.

NOTE A definition of dependent failure is provided in 3.2.12.

**9.4.2** The assessment shall consider the following:

- independence between protection layers;
- diversity between protection layers;
- physical separation between different protection layers;
- common cause failures between protection layers and between protection layers and BPCS.

NOTE 1 Common causes from the process can be addressed. Plugging of relief valves may cause the same problems as plugging of sensors in a SIS.

NOTE 2 Independence and physical separation can be addressed. A Human Machine Interface, SIS/BPCS networks or bypass means can cause common cause failure.

## **10 SIS safety requirements specification (SRS)**

### **10.1 Objective**

The objective of Clause 10 is to specify the requirements for the SIS, including any application programs and the architecture of the SIS.

### **10.2 General requirements**

The safety requirements shall be derived from the allocation of SIF and from those requirements identified during H&RA. The SIS requirements shall be expressed and structured in such a way that they are

- clear, precise, verifiable, maintainable and feasible;
- written to aid comprehension and interpretation by those who will utilise the information at any phase of the safety life-cycle.

### **10.3 SIS safety requirements**

**10.3.1** Addresses issues that shall be considered when developing the SIS safety requirements.

**10.3.2** These requirements shall be sufficient to design the SIS and shall include a description of the intent and approach applied during the development of the SIS safety requirements as applicable:

- a description of all the SIF necessary to achieve the required functional safety (e.g., a cause and effect diagram, logic narrative);
- a list of the plant input and output devices related to each SIF which is clearly identified by the plant means of equipment identification (e.g., field tag list);
- requirements to identify and take account of common cause failures;
- a definition of the safe state of the process for each identified SIF, such that a stable state has been achieved and the specified hazardous event has been avoided or sufficiently mitigated;
- a definition of any individually safe process states which, when occurring concurrently, create a separate hazard (e.g., overload of emergency storage, multiple relief to flare system);
- the assumed sources of demand and demand rate on each SIF;
- requirements relating to proof test intervals;
- requirements relating to proof test implementation;
- response time requirements for each SIF to bring the process to a safe state within the process safety time;

NOTE See IEC 61511-2:2016 for further discussion of process safety time.

- the required SIL and mode of operation (demand/continuous) for each SIF;
- a description of SIS process measurements, range, accuracy and their trip points;
- a description of SIF process output actions and the criteria for successful operation, e.g., leakage rate for valves;
- the functional relationship between process inputs and outputs, including logic, mathematical functions and any required permissives for each SIF;
- requirements for manual shutdown for each SIF;
- requirements relating to energize or de-energize to trip for each SIF;
- requirements for resetting each SIF after a shutdown (e.g., requirements for manual, semi-automatic, or automatic final element resets after trips);
- maximum allowable spurious trip rate for each SIF;
- failure modes for each SIF and desired response of the SIS (e.g., alarms, automatic shutdown);
- any specific requirements related to the procedures for starting up and restarting the SIS;
- all interfaces between the SIS and any other system (including the BPCS and operators);
- a description of the modes of operation of the plant and requirements relating to SIF operation within each mode;
- the application program safety requirements as listed in 10.3.2;
- requirements for bypasses including written procedures to be applied during the bypassed state which describe how the bypasses will be administratively controlled and then subsequently cleared;
- the specification of any action SIF necessary to achieve or maintain a safe state of the process in the event of fault(s) being detected in the SIS, taking into account of all relevant human factors;
- the mean repair time which is feasible for the SIS, taking into account the travel time, location, spares holding, service contracts, environmental constraints;
- identification of the dangerous combinations of output states of the SIS that need to be avoided;
- identification of the extremes of all environment conditions that are likely to be encountered by the SIS during shipping, storage, installation and operation. This may require consideration of the following: temperature, humidity, contaminants, grounding, electromagnetic interference/radio frequency interference (EMI/RFI), shock/vibration,

electrostatic discharge, electrical area classification, flooding, lightning, and other related factors;

- identification of normal and abnormal process operating modes for both the plant as a whole (e.g., plant start-up) and individual plant operating procedures (e.g., equipment maintenance, sensor calibration or repair). Additional SIFs may be required to support these process operating modes;
- definition of the requirements for any SIF necessary to survive a major accident event, e.g., time required for a valve to remain operational in the event of a fire.

**10.3.3** The application program safety requirements shall be derived from the SRS and chosen architecture (arrangement and internal structure) of the SIS. The application program safety requirements may be located in the SRS or in a separate document (e.g., application program requirements specification). The input to the application program safety requirements for each SIS subsystem shall include:

- a) the specified safety requirements of each SIF, including sensor voting, etc.;
- b) the requirements resulting from the SIS architecture and the safety manual such as limitations and constraints of the hardware and embedded software;
- c) any requirements of safety planning arising from 5.2.4.

**10.3.4** The application program safety requirements shall be specified for each programmable SIS device necessary to implement the required SIF consistent with the architecture of the SIS.

**10.3.5** The application program safety requirements specification shall be sufficiently detailed to allow the design and implementation to achieve the required functional safety and to allow a functional safety assessment to be carried out. The following shall be considered:

- the SIFs supported by the application program and their SIL;
- real time performance parameter such as, CPU capacity, network bandwidth, acceptable real time performance in the presence of faults, and all trip signals are received within a specified time period;
- program sequencing and time delays if applicable;
- equipment and operator interfaces and their operability;
- all relevant modes of operation of the process as specified in the SRS;
- action to be taken on bad process variable such as sensor value out of range, excessive range of change, frozen value, detected open circuit, detected short circuit;
- functions enabling proof testing and automated diagnostics tests of external devices (e.g., sensors and final elements) performed in the application program;
- application program self-monitoring (e.g., application driven watch-dogs and data range validation);
- monitoring of other devices within the SIS (e.g., sensors and final elements);
- any requirements related to periodic testing of SIF when the process is operational;
- references to the input documents (e.g., specification of the SIF, configuration or architecture of the SIS, hardware safety integrity requirements of the SIS);
- the requirements for communication interfaces, including measures to limit their use and the validity of data and commands both received and transmitted;
- process dangerous states (for example closure of two isolation gas valves at the same time that could lead to pressure fluctuations thus leading to a dangerous state) generated by the application program shall be identified and avoided;
- definitions of process variable validation criteria for each SIF.

**10.3.6** The application program safety requirements specification shall be expressed and structured in such a way that they:

- describe the intent and approach underpinning the application program safety requirements;
- are clear and understandable to those who will utilize the document at any phase of the SIS safety life-cycle; this includes the use of terminology and descriptions which are unambiguous and understood by all users (e.g., plant operators, maintenance personnel, application programmers);
- are verifiable, testable, modifiable;
- are traceable back through all deliverables including the detailed design documents, the SRS and the H&RA that identifies the required SIF and SIL.

## **11 SIS design and engineering**

### **11.1 Objective**

The objective of the requirements of Clause 11 is to design one or multiple SIS to provide the SIF and meet the specified integrity requirements (e.g., SIL, associated risk reduction, PFD and /or PFH).

### **11.2 General requirements**

**11.2.1** The design of the SIS shall be in accordance with the SIS safety requirements specifications, taking into account all the requirements of Clause 11.

**11.2.2** Where the SIS is to implement both SIFs and non-SIFs then all the hardware, embedded software and application program that can negatively affect any SIF under normal and fault conditions shall be treated as part of the SIS and comply with the requirements for the highest SIL of any of the SIFs it can impact.

**11.2.3** Where the SIS is to implement SIF of different SIL, then the shared or common hardware and embedded software and application program shall conform to the highest SIL.

NOTE Embedded software or application programs of different SIL could coexist in the same device provided it can be demonstrated that the SIF of lower SIL cannot negatively affect the SIF of the higher SIL.

**11.2.4** If it is intended not to qualify the BPCS to the IEC 61511 series, then the SIS shall be designed to be separate and independent from the BPCS to the extent that the safety integrity of the SIS is not compromised.

NOTE 1 Operating information can be exchanged but not compromise the functional safety of the SIS.

NOTE 2 Devices of the SIS can also be used for functions of the BPCS if it can be demonstrated that a failure of the BPCS does not compromise the SIF of the SIS.

**11.2.5** Requirements for operability, maintainability, diagnostics, inspection and testability shall be addressed during the design of the SIS in order to reduce the likelihood of dangerous failures.

**11.2.6** The design of the SIS shall take into account human capabilities and limitations and be suitable for the tasks assigned to operators and maintenance staff. The design of operator interfaces shall follow good human factors practice and shall accommodate the likely level of training that operators should receive.

NOTE 1 For example, human factor studies may be necessary if operation requires data entry of limits or other operator input on a regular basis.

**11.2.7** The SIS shall be designed in such a way that once it has placed the process in a safe state, the process shall remain in the safe state until a reset has been initiated unless otherwise directed by the SRS.

**11.2.8** Manual means (e.g., emergency stop push button), independent of the logic solver, shall be provided to actuate the SIS final elements unless otherwise directed by the SRS.

**11.2.9** The design of the SIS shall take into consideration all aspects of independence and dependency between the SIS and BPCS, and the SIS and other protection layers.

**11.2.10** A device used by the BPCS shall not be used by the SIS where a failure of that device may result in both a demand on the SIF and a dangerous failure of the SIF, unless an analysis has been carried out to confirm that the overall risk is acceptable.

NOTE When a part of the SIS is also used for control purposes and a dangerous failure of the common equipment would cause a demand on the function performed by the SIS, then a new risk is introduced. The additional risk is dependent on the dangerous failure rate of the shared device because if the shared device fails, a demand will be created immediately to which the SIS may not be capable of responding. For that reason, additional analysis can be necessary in these cases to ensure that the dangerous failure rates of the shared devices are sufficiently low. Sensors and valves are examples where sharing of equipment with the BPCS is often considered.

**11.2.11** For any SIS device that on loss of utility (e.g., electrical power, air, hydraulics or pneumatic supply) does not fail to the safe state, loss of utility and SIS circuit integrity shall be detected and alarmed (e.g., end-of-line monitoring, supply pressure measurement, hydraulic or pneumatic pressure monitoring) and action taken according to 11.3.

NOTE 1 Utility integrity can be improved through using a supplementary supply (e.g., battery back-up, uninterruptible power supplies, air reservoir, hydraulic accumulator, second gas supply).

NOTE 2 The loss of a utility is likely to affect multiple SIFs and, possibly, multiple SISs. Hence common cause failure of multiple SIFs can be considered.

**11.2.12** The design of the SIS shall be such that it provides the necessary resilience against the identified security risks (see 8.2.4).

NOTE Guidance related to SIS security is provided in ISA TR84.00.09 and IEC 62443-2-1:2010.

**11.2.13** A safety manual covering operation, maintenance, fault detection and constraints associated with the SIS shall be available covering the intended configurations of the devices and the intended operating environment.

**11.2.14** All communications used to implement a SIF shall be established using techniques appropriate for safety applications to meet the required SIL.

### **11.3 Requirements for system behaviour on detection of a fault**

**11.3.1** When a dangerous fault in a SIS has been detected (by diagnostic tests, proof tests or by any other means) then compensating measures shall be taken to maintain safe operation. If safe operation cannot be maintained, a specified action to achieve or maintain a safe state of the process shall be taken. Where the compensating measures depend on an operator taking specific action in response to an alarm (e.g., opening or closing a valve) then the alarm shall be considered part of the SIS.

NOTE 1 The specified action (fault reaction) required to achieve or maintain a safe state of the process can be specified in the SRS (see 10.3.1). It can consist of the safe shutdown of the process or of that part of the process which relies on the faulty SIS for risk reduction.

NOTE 2 The compensating measures required for continued safe operations can depend on safety integrity requirements, the tolerable risk associated with the hazardous event, the hardware fault tolerance of the SIS, the anticipated MRT and the availability of any other layers of protection. In some cases it can be adequate to ensure action is taken to ensure repair of the dangerous failure within the assumed MPRT in the calculation of the PFDavg but in other cases it can be judged necessary to provide other measures to compensate for the reduced risk reduction until the SIS is fully restored. See also 16.2.3.

**11.3.2** Where any dangerous fault in an SIS is brought to the attention of an operator by an alarm then the alarm shall be subject to appropriate proof testing and management of change.



## 11.4 Hardware fault tolerance

**11.4.1** The SIS shall have a minimum HFT with respect to each SIF it implements.

NOTE This does not exclude the possibility that the HFT may be reduced below the minimum requirement at certain times during operation of the system following the occurrence of faults.

**11.4.2** When the SIS can be split into independent SIS subsystems (e.g. sensors, logic solvers and final elements), then the HFT can be assigned at the SIS subsystem level.

**11.4.3** The HFT of the SIS or its SIS subsystems shall be in accordance with;

- 11.4.5 to 11.4.9 of clause 11 or,
- the requirements of 7.4.4.2 (route 1H) of IEC 61508-2:2010 or,
- the requirements of 7.4.4.3 (route 2H) of IEC 61508-2:2010.

NOTE The route developed in IEC 61511 is derived from route 2<sub>H</sub> of IEC 61508-2:2010.

**11.4.4** When determining the achieved HFT, certain faults may be excluded, provided that the likelihood of them occurring is very low in relation to the safety integrity requirements. Any such fault exclusions shall be justified and documented.

NOTE Further information about fault exclusion can be found in ISO13849-1:2006 and ISO13849-2:2012.

**11.4.5** The minimum HFT for a SIS (or its SIS subsystems) implementing a SIF of a specified SIL shall be in accordance with Table 6 and if appropriate 11.4.6 and 11.4.7.

NOTE The HFT requirements in Table 6 represent the minimum system or, where relevant, the SIS subsystem redundancy. Depending on the application, device failure rate and proof-testing interval, additional redundancy can be required to satisfy the failure measure for the SIL of the SIF according to 11.9.

**Table 6 – Minimum HFT requirements according to SIL**

SIL	Minimum required HFT
1 (any mode)	0
2 (low demand mode)	0
2 (continuous mode)	1
3 (high demand mode or continuous mode)	1
4 (any mode)	2

**11.4.6** For a SIS or SIS subsystem that does not use FVL or LVL programmable devices and if the minimum HFT as specified in Table 6, would result in additional failures and lead to decreased overall process safety, then the HFT may be reduced. This shall be justified and documented. The justification shall provide evidence that the proposed architecture is suitable for its intended purpose and meets the safety integrity requirements.

NOTE Fault tolerance is the preferred solution to achieve the required confidence that a robust architecture has been achieved. When 11.4.6 applies, the purpose of the justification is to demonstrate that the proposed alternative architecture provides an equivalent or better solution. This may vary depending on the application and/or the technology in use; examples include: back-up arrangements (e.g., analytical redundancy, replacing a failed sensor output by physical calculation results from other sensors outputs); using more reliable items of the same technology (if available); changing for a more reliable technology; decreasing common cause failure impact by using diversified technology; increasing the design margins; constraining the environmental conditions (e.g. for electronic components); decreasing the reliability uncertainty by gathering more field feedback or expert judgment.

**11.4.7** If a fault tolerance equal to zero results from applying 11.4.6, the justification required by 11.4.6 shall provide evidence that the related dangerous failure modes can be excluded, in accordance with 11.4.4 including consideration of the potential for systematic failures.

**11.4.8** FVL and LVL programmable devices shall have diagnostic coverages not less than 60 %.

**11.4.9** Reliability data used in the calculation of the failure measure shall be determined by an upper bound statistical confidence limit of no less than 70 %.

## **11.5 Requirements for selection of devices**

### **11.5.1 Objectives**

The objectives of the requirements of 11.5 are to:

- specify the requirements for the selection of devices which are to be used as part of the SIS;
- specify the requirements to enable a device to be integrated in the architecture of a SIS;
- specify acceptance criteria for devices in terms of associated SIF and safety integrity requirements.

### **11.5.2 General requirements**

**11.5.2.1** Devices selected for use as part of a SIS with a specified SIL shall be in accordance with IEC 61508-2:2010 and IEC 61508-3:2010 and/or 11.5.3 through 11.5.6, as appropriate.

NOTE Devices assessed against IEC 61508-2:2010 and IEC 61508-3:2010 can be applied in accordance with the requirements for systematic capability in IEC 61508-2:2010.

**11.5.2.2** All devices shall be suitable for the operating environment as determined through consideration of the manufacturer's documentation, the constraints within the SRS and the reliability parameters assumed in respect of 11.9. Suitability of the selected devices shall always be considered in the context of the operating environment.

NOTE Devices may exhibit different failure rates dependent on the operating environment and mode of operation. Failure rate data available from manufacturers may not be valid in all applications. For example, the failure rate and failure mode distribution can be different for a valve that is frequently exercised versus one that stands still for long periods of time.

### **11.5.3 Requirements for the selection of devices based on prior use**

**11.5.3.1** Appropriate evidence shall be available that the devices are suitable for use in the SIS.

NOTE 1 The main intent of the prior use evaluation is to gather evidence that the dangerous systematic faults have been reduced to a sufficiently low level compared to the required safety integrity.

NOTE 2 Level of detail of the evidence can be in accordance with the complexity of the considered device.

NOTE 3 A prior use evaluation involves gathering documented information concerning the device performance in a similar operating environment. Prior use demonstrates the functionality and integrity of the installed device, including the process interfaces, full device boundary, communications, and utilities. The main intent of the prior use evaluation is to gather evidence that the dangerous systematic faults have been reduced to a sufficiently low level compared to the required safety integrity.

NOTE 4 Prior use data can contribute to a database for the calculation of hardware failure rates as described in 11.9.3.

**11.5.3.2** The evidence of suitability shall include the following:

- consideration of the manufacturer's quality, management and configuration management systems;
- adequate identification and specification of the devices;
- demonstration of the performance of the devices in similar operating environments;

NOTE 1 In the case of field devices (e.g., sensors and final elements) fulfilling a given specification, the behaviour of the device in the operating environment is usually identical in safety and non-safety applications. Therefore, evidence of the performance of similar devices in non-safety applications can also be used to satisfy this requirement.

- the volume of the operating experience.

NOTE 2 For field devices, information relating to operating experience is mainly recorded in the user's list of equipment approved for use in their facilities, based on an extensive history of successful performance in safety and non-safety applications, and on the elimination of equipment not performing in a satisfactory manner. The list of field devices can be used to support claims of experience in operation, provided that:

- the list is updated and monitored regularly;
- field devices are only added when sufficient operating experience has been obtained;
- field devices are removed when they show a history of not performing in a satisfactory manner;
- the operating environment is included in the list where relevant.

NOTE 3 Device performance is highly affected by the operating environment. It is generally recommended that selection of devices can be based on adequate performance of an installed sufficient number of devices in multiple installations for a sufficient operating time. The gained experience can allow time to reveal early failures, such as those related to specification, handling, installation, and commissioning.

NOTE 4 The amount of operational experience to gain credible statistical reliability data is typically much higher compared to the operational experience necessary to get evidence of prior use.

**11.5.3.3** All devices selected on the basis of prior use shall be identified by a specified revision number and shall be under the control of a management of change procedure. In the case of a change being made to the device, the continued validity of the evidence of prior use shall be justified by evaluating the significance of the change made.

#### **11.5.4 Requirements for selection of FPL programmable devices (e.g., field devices) based on prior use**

**11.5.4.1** For SIL 1, SIL 2, and SIL 3, the requirements of 11.5.2 and 11.5.3 apply, together with the following subclauses.

**11.5.4.2** All configuration options of the device possibly influencing safety shall be identified and considered. It is important to check that wherever specific settings are not defined that the default settings of the device are confirmed to be appropriate. Unused features of the devices shall be identified in the evidence of suitability, and it shall be established that they are unlikely to jeopardize the required SIF.

**11.5.4.3** For the specific configuration and operating environment of the device, the evidence of suitability shall consider:

- characteristics of input and output signals;
- modes of use;
- functions and configurations used;
- prior use in similar operating environments.

**11.5.4.4** In addition, for SIL 3 applications, an assessment of the FPL device shall be carried out to show that:

- the FPL device is both able to perform the required functions and that prior use has shown there is a low enough probability that it will fail in a way which could lead to a hazardous event when used as part of the SIS, due to either random hardware failures or systematic faults in hardware or software;
- appropriate standards for hardware and software have been applied;
- the FPL device has been used or tested in configurations representative of the intended operational profiles.

### **11.5.5 Requirements for selection of LVL programmable devices based on prior use**

**11.5.5.1** The following requirements apply to PE devices used in SISs which implement SIL 1 or SIL 2 SIFs.

**11.5.5.2** The requirements of 11.5.4 apply.

**11.5.5.3** Where there is any difference between the operating environment of a device as experienced previously, and the operating environment of the device when used within the SIS, then any such differences shall be identified and there shall be an assessment based on analysis and testing, as appropriate, to show that the likelihood of systematic faults when used in the SIS is sufficiently low.

**11.5.5.4** The operating experience considered necessary to justify the suitability shall be determined taking into account:

- the SIL of the SIF;
- the complexity and functionality of the devices.

**11.5.5.5** For SIL 1 or 2 applications, a safety configured PE logic solver may be used provided that all the following additional provisions are met:

- understanding of unsafe failure modes;
- use of techniques for safety configuration that address the identified failure modes;
- the embedded software has a good history of use for safety applications;
- protection against unauthorized or unintended modifications.

NOTE A safety configured PE logic solver is a general purpose industrial grade PE logic solver which is specifically configured by the OEM, a systems engineer or the end-user for use in safety applications.

**11.5.5.6** A formal assessment of any PE logic solver used in a SIL 2 application shall be carried out to show that:

- it is both able to perform the required functions and that prior use has shown there is a low enough probability that it will fail in a way which could lead to a hazardous event when used as part of the SIS, due to either random hardware failures or systematic faults in hardware or software;
- measures are implemented to detect faults during program execution and initiate appropriate responses; these measures shall comprise all of the following:
  - program sequence monitoring;
  - protection of code against modifications or failure detection by on-line monitoring;
  - failure assertion or diverse programming;
  - range check of variables or plausibility check of values;
  - modular approach;
  - appropriate coding standards have been used for the embedded and utility software;
  - testing in typical configurations, with test cases representative of the intended operational profiles;
  - trusted verified software modules and components have been used;
  - the system has undergone dynamic analysis and testing;
  - the system does not use artificial intelligence or dynamic reconfiguration;
  - documented fault-insertion testing (negative testing) has been performed.

### 11.5.6 Requirements for selection of FVL programmable devices

When the applications are programmed using a FVL, the PE device shall be in accordance with IEC 61508-2:2010 and IEC 61508-3:2010.

## 11.6 Field devices

**11.6.1** Field devices shall be selected and installed to minimize failures that could result in inaccurate information due to conditions arising from the operating environment. Conditions that should be considered include corrosion, freezing of materials in pipes, suspended solids, polymerization, coking, temperature and pressure extremes, condensation in dry-leg impulse lines, and insufficient condensation in wet-leg impulse lines.

**11.6.2** Energize to trip circuits shall apply means to ensure circuit and power supply integrity.

NOTE 1 An example of such means is an end-of-line monitor, where a pilot current is continuously monitored to detect circuit continuity and where the pilot current is not of sufficient magnitude to affect proper I/O operation.

NOTE 2 Additional requirements for loss of power can be found in 11.2.11.

**11.6.3** Smart sensors shall be write-protected to prevent inadvertent modification, unless appropriate safety review (e.g., H&RA) allows the use of read/write.

NOTE The review can take into account human factors such as failure to follow procedures.

## 11.7 Interfaces

### 11.7.1 General

Interfaces to the SIS can include, but are not limited to:

- operator interface(s);
- maintenance/engineering interface(s);
- communication interface(s).

### 11.7.2 Operator interface requirements

**11.7.2.1** Where the SIS operator interface is via the BPCS operator interface, account shall be taken of credible failures that may occur in the BPCS operator interface.

NOTE This can include preparing plans to enable an orderly safe shutdown in the event of total failure of the operational displays.

**11.7.2.2** The design of the SIS shall minimize the need for operator selection of options and the need to bypass the system while hazards are present. If the design does require the use of operator actions, the design should include facilities for protection against operator error.

NOTE If the operator has to select a particular option, there can be a confirmation step.

**11.7.2.3** Bypass switches or means shall be protected to prevent unauthorized use (e.g., by key locks or passwords in conjunction with effective management controls).

NOTE Consideration can be given to enforcing time limits on bypass operation and to limiting the number of bypasses that can be active at any one time.

**11.7.2.4** The SIS status information that is critical to maintaining the SIF shall be available as part of the operator interface. This information may include:

- where the process is in its sequence;
- indication that SIS protective action has occurred;

- indication that a protective function is bypassed;
- indication that automatic action(s) such as degradation of voting and/or fault handling has occurred;
- status of sensors and final elements;
- the loss of energy where that energy loss impacts safety;
- the results of diagnostics;
- failure of environmental conditioning equipment which is necessary to support the SIS.

**11.7.2.5** The SIS operator interface design (see 11.7.2.7) shall be such as to prevent changes to the SIS application program.

**11.7.2.6** Where information is transferred from the BPCS to the SIS, systems, equipment or procedures shall be applied to confirm that the correct information has been transferred and that the safety integrity of the SIS is not compromised.

NOTE The systems, equipment or procedures used can include control over selective writing from the BPCS to specific SIS variables.

**11.7.2.7** The design of the SIS operator interface via the BPCS operator interface shall be such that provision of incorrect information or data from the BPCS to the SIS shall not compromise safety.

### **11.7.3 Maintenance/engineering interface requirements**

**11.7.3.1** The design of the SIS maintenance/engineering interface shall ensure that any failure of this interface shall not adversely affect the ability of the SIS to carry out the required SIFs. This may require disconnecting of maintenance/engineering interfaces, such as programming panels, during normal SIS operation.

**11.7.3.2** The maintenance/engineering interface shall provide the following functions with access security protection to each:

- SIS mode of operation, program, data, means of disabling alarm communication, test, bypass, maintenance;
- SIS diagnostic, voting and fault handling services;
- add, delete, or modify application program;
- data necessary to troubleshoot the SIS;
- where bypasses are required they should be installed such that alarms and manual shutdown facilities are not disabled.

**11.7.3.3** The maintenance/engineering interface shall not be used as the operator interface.

**11.7.3.4** Enabling and disabling the read-write access shall be carried out only by a configuration management process using the maintenance/engineering interface with appropriate documentation and security measures such as authentication and user secure channels.

### **11.7.4 Communication interface requirements**

**11.7.4.1** The design of any SIS communication interface shall ensure that any failure of the communication interface shall not adversely affect the ability of the SIS to achieve or maintain a safe state of the process.

**11.7.4.2** When the SIS is able to communicate with the BPCS and peripherals, the communication interface, BPCS, or peripherals shall not adversely impact any of the SIFs within the SIS.

**11.7.4.3** The communication interface shall be sufficiently robust to withstand electromagnetic interference including power surges without causing a dangerous failure of the SIS.

**11.7.4.4** The communication interface shall be suitable for communication between devices referenced to different electrical ground potentials.

NOTE An alternate medium (e.g., fibre optics) can be required.

## **11.8 Maintenance or testing design requirements**

**11.8.1** The design shall allow for testing of the SIS either end-to-end or in segments. Where the interval between scheduled process downtime is greater than the proof test interval, then on-line test facilities are required.

NOTE The term “end-to-end” means from process fluid at sensor end to process fluid at actuation end.

**11.8.2** When on-line proof testing is required, test facilities shall be an integral part of the SIS design.

**11.8.3** When test or bypass facilities are included in the SIS, they shall conform with the following:

- The SIS shall be designed in accordance with the maintenance and testing requirements defined in the SRS;
- The operator shall be alerted to the bypass of any portion of the SIS via an alarm or operating procedure.

**11.8.4** The maximum time the SIS is allowed to be in bypass (repair or testing) while safe operation of the process is continued shall be defined.

**11.8.5** Compensating measures that ensure continued safe operation shall be provided in accordance with 11.3 when the SIS is in bypass (repair or testing).

**11.8.6** Forcing of inputs and outputs in PE SIS shall not be used as a part of application program(s), operating procedure(s) and maintenance (except as noted below).

Forcing of inputs and outputs without taking the SIS out of service shall not be allowed unless supplemented by procedures and access security. Any such forcing shall be announced or set off an alarm, as appropriate.

## **11.9 Quantification of random failure**

**11.9.1** The calculated failure measure of each SIF shall be equal to, or better than, the target failure measure related to the SIL as specified in the SRS. This shall be determined by calculation.

NOTE In complex applications, the hazardous event frequency can be used as an alternative to the target failure measures (e.g., where different demand causes have different safety integrity requirements or where non-independent SISs act in sequence).

**11.9.2** The calculated failure measure of each SIF due to random failures shall take into account all contributing factors including the following:

- a) the architecture of the SIS and of its SIS subsystems where relevant as they relate to each SIF under consideration;
- b) the estimated failure rate related to each failure mode, due to random hardware failures, which would contribute to a dangerous failure of the SIS but which are detected by diagnostic tests;

- c) the estimated failure rate related to each failure mode, due to random hardware failures, which would contribute to a dangerous failure of the SIS which are undetected by the diagnostic tests but which are detected by proof tests;
- d) the estimated failure rate related to each failure mode, due to random hardware failure, which would contribute to a dangerous failure of the SIS which are undetected by the diagnostic tests and undetected by proof tests;
- e) the susceptibility of the SIS to failures caused by the proof tests themselves;
- f) the susceptibility of the SIS to common cause failures;
- g) the diagnostic coverage of any periodic diagnostic tests, the associated diagnostic test interval and the probability of failure of the diagnostic facilities;
- h) the coverage of any periodic proof tests, the associated proof test procedure and the reliability for the proof test facilities and procedure;
- i) the repair times for detected failures and the state of the SIS during repairs (on line or off line);
- j) the estimated dangerous failure rate of any communication process in any modes which would cause a dangerous failure of the SIS (both detected and undetected by diagnostic tests);
- k) the estimated likelihood that operator response would cause a dangerous failure of the SIS (both detected and undetected by diagnostic tests);
- l) the reliability of any utility necessary for the SIS.

NOTE Several modelling approaches are available and the most appropriate approach is a matter for the analyst and can depend on the circumstances. Available means include (see IEC 61508-6:2010, annex B):

- cause consequence analysis;
- reliability block diagrams;
- fault-tree analysis;
- Markov models;
- Petri nets models.

The probabilistic calculations can be performed analytically or by numerical simulation (e.g., Monte Carlo simulation).

**11.9.3** The reliability data used when quantifying the effect of random failures shall be credible, traceable, documented, justified and shall be based on field feedback from similar devices used in a similar operating environment.

NOTE 1 This includes user collected data, vendor/provider/user data derived from data collected on devices, data from general field feedback reliability databases, etc. In some cases, engineering judgement can be used to assess missing reliability data or evaluate the impact on reliability data collected in a different operating environment.

NOTE 2 The lack of reliability data reflective of the operating environment is a recurrent shortcoming of probabilistic calculations. End-users can organize relevant device reliability data collections in accordance with IEC 60300-3-2:2004 or ISO 14224:2006 to improve the implementation of the IEC 61511 series.

NOTE 3 Vendor data based on returns can be restricted to a population where there is full knowledge of the operational environment and fully recorded in accordance with IEC 60300-3-2:2004 or ISO 14224:2006. The user can also record the operational environment for the SIF and be able to demonstrate that the vendor's operational environment data matches the environment of the SIF.

**11.9.4** The reliability data uncertainties shall be assessed and taken into account when calculating the failure measure.

NOTE 1 The reliability data uncertainties can be evaluated according to the amount of field feedback (less field feedback results in more uncertainty) or/and exercise of expert judgement. Published standards (IEC 60605-4), Bayesian approaches, engineering judgement techniques, etc. can be used to estimate the reliability data uncertainties.

NOTE 2 The following techniques can be used for calculating the failure measures (more information can be found in IEC 61511-2:2016):

- use of an upper bound confidence of 70 % for each input reliability parameter instead of its mean in order to obtain conservative point estimations of the failure measures, or;



- use the probabilistic distributions functions of input reliability parameters, perform Monte Carlo simulations to obtain an histogram representing the distribution of the failure measure and assess a conservative value from this distribution (e.g., that there is a 90 % confidence that the true failure measure is better than the value calculated).

**11.9.5** If, for a particular design, the target failure measure for the relevant SIF is not achieved then:

- a) identify the devices or parameters contributing most to the failure measure;

NOTE Fault tree cut-set analysis can be useful here.

- b) evaluate the effect of possible improvement measures on the identified devices or parameters (e.g., more reliable devices, additional defences against common mode failures, increased diagnostic or proof test coverage, increased redundancy, reduced proof test interval, staggering tests, etc.);
- c) select and implement improvement measures to establish the new result;
- d) compare the new result to the target failure measure and repeat the steps a) to d) until the target failure measure is achieved in a conservative manner.

## **12 SIS application program development**

### **12.1 Objective**

The objective of Clause 12 is to define the requirements for the development of the application program.

### **12.2 General requirements**

**12.2.1** The application program of the SIS shall be in accordance with the application program safety requirements (see 10.3.3) and all the requirements of this clause for all SIL up to and including SIL 3.

**12.2.2** The application programmer shall review the information in the SRS and the application program safety requirements to ensure that the requirements are comprehensive, unambiguous, understandable and consistent. Any deficiencies in the application program safety requirements shall be identified and resolved, and if changes are made to the application program safety requirements, an impact analysis shall be carried out.

**12.2.3** The IEC 61511 series addresses programming in Limited Variability Languages (LVL) and the use of devices using Fixed Program Languages (FPL). The IEC 61511 series does not address Full Variability Language (FVL) and the IEC 61511 series does not address SIL 4 application programming. Where function blocks are written in FVL then these shall be developed and modified under IEC 61508-3:2010.

**12.2.4** Where the application program of the SIS is to implement both safety and non-safety functions, then all of the application program shall be treated as part of the SIS and shall comply with this standard and in addition, it shall be shown through assessment and test that the non-safety functions cannot interfere with the safety functions.

**12.2.5** The application program shall be designed in such a way as to ensure that once the SIS has placed the process in a safe state, the process remains in the safe state, including under loss of power conditions and on power restoration, until a reset has been initiated unless otherwise directed by the SRS.

NOTE 1 If the SIF does not have a reset then there can be a documented engineering argument as to why it is acceptable to reinitiate the process without requiring the safe delay a reset would impose.

NOTE 2 More information can be found in 11.2.7.

**12.2.6** During SIS start-up (or power up) the application program shall ensure that safety outputs remain in the safe state (typically de-energized state) until a reset has been initiated unless otherwise directed by the SRS.

**12.2.7** The application program shall be designed in such a way that all parts of the application program are executed on every application program scan unless there is a specific alternate requirement that is supported in the safety manual. Process safety time requirements shall be considered when establishing application program scanning requirements.

**12.2.8** The SIS application program and data shall be subject to modification, revision control, version management, back-up and restoration procedures.

**12.2.9** The application program specifies requirements for application programming for users and integrators of SISs. In particular, requirements for the following are specified:

- SIS safety life-cycle phases and activities that are to be applied during the design and development of the application program. These requirements include the application of measures and techniques, which are intended to avoid errors in the application program and to control failures which may occur;
- information relating to the application program validation to be passed to the organization carrying out the SIS integration;
- preparation of information and procedures concerning the application program needed by the user for the operation and maintenance of the SIS;
- procedures and specifications to be met by the organization carrying out modifications of the application program.

### **12.3 Application program design**

**12.3.1** An application program design shall address all SIS logic including all process operating modes for each SIF.

**12.3.2** The input to the application program design shall be the SRS including the application program requirements (see Clause 10), the SIS architecture (see Clause 11) and the means and tools for developing the application program design (see 12.6). The application program design shall be consistent with and traceable back to the SRS.

**12.3.3** The application program design shall allow an assessment of functional safety to be carried out.

**12.3.4** The application program design and its decomposition into modules if applicable, shall address how the requirements are to be implemented, including the following as appropriate:

- the functions that enable the process to achieve or maintain a safe state;
- the specification of all identified application program components, and the description of connections and interactions between identified components;
- the timing constraints associated with the application program functions and their implementation in program scan time(s);
- a detailed description of the standard library modules (function blocks) being used;
- a detailed description of the application specific modules (function blocks) being used;
- a description of the way memory allocation has been achieved;
- the list of global variables used and the way in which their integrity is protected;
- identification of all non-SIF and the interfaces to non-safety related parts of the application program, to ensure that they cannot affect the proper operation of any SIF;

- definition of input and output interfaces, including tag listings and the associated data types;
- details of the data exchanged between the SIS application program and the operator interfaces;
- details of the data exchanged between the SIS application program and the BPCS and peripherals such as printers, data storage, etc.;
- how external and internal diagnostic information will be processed and logged;
- detailed description of how the operation and maintenance interfaces are implemented, including the way in which alarms are prioritised, indicated and accepted;
- a detailed description of any application level diagnostics that may be implemented such as external watch dogs, application data integrity checking, sensor validation to meet the required SIL;
- system configuration checks including the existence and accessibility of expected hardware devices and software modules;
- how the complexity in the application program design is minimised e.g., through use of modular design and simple functionality;
- functions related to the detection, annunciation and management of faults in SIS subsystems;
- functions related to the periodic testing of SIF on-line;
- functions related to the periodic testing of SIF off-line;
- functions that allow maintenance of the SIS to be carried out safely;
- references to documents on which the application program design specification is based.

#### **12.3.5** The application program design shall ensure:

- completeness with respect to the SRS and its intended purpose;
- correctness with respect to the SRS and its intended purpose;
- freedom from ambiguity, i.e., clear to those who will utilize the document at any stage of the SIS safety life-cycle; this includes the use of terminology and descriptions which are unambiguous and understood by plant operators and system maintainers, as well as the application programmers;
- freedom from design faults.

### **12.4 Application program implementation**

**12.4.1** The application program development methodology shall comply with the development tools and restrictions given by the manufacturer of the SIS PE subsystem on which the application program shall be used.

**12.4.2** The following information shall be contained in the application program or related documentation:

- a) the application program originator;
- b) a description of the purpose of the application program;
- c) the versions of the safety manuals that were used;
- d) identification of the dependency of each SIF on the parts (modules) of the application program;
- e) traceability to the application program safety requirements specification;
- f) identification of each SIF and its SIL;
- g) identification and description of the symbols used, including logic conventions, standard library functions, application library functions;

- h) identification of the SIS logic solver input and output signals;
- i) where the overall SIS utilises communications, a description of the communications information flow;

NOTE An example would be where a SIF uses several logic solvers.

- j) a description of the program structure, including a description of the order of the logical processing of data with respect to the input/output sub-systems and any limitations imposed by scan times;
- k) If required by the SRS, the means by which:
  - the correctness of field data is ensured, (e.g., comparison between analog sensors to improve the diagnostic coverage);
  - the correctness of data sent over a communication link is ensured (e.g., when communicating from an HMI, before implementation of a command an 'ack' or 'acknowledge' is transmitted);
  - communications are made secure (e.g., cyber security measures);
- l) version identification and a history of changes.

**12.4.3** If previously developed application program library functions are to be used as part of the design, their suitability shall be justified and based upon:

- compliance to IEC 61508; if proven-in-use evaluation for FVL in compliance to IEC 61508-3:2010 is undertaken, the programmable devices on which the application program library functions execute shall also be evaluated as proven-in-use according to IEC 61508-2:2010; or
- compliance to IEC 61511 prior use requirements (see 11.5.4 or 11.5.5) when using FPL or LVL;
- in all cases, demonstrating that any unused functions do not adversely impact the application program.

**12.4.4** The application program shall be produced in a structured way so as to achieve:

- modular decomposition of the functionality;
- keep the complexity of SIF application program to a minimum consistent with that of the complexity of the required SIF;
- testability of functionality (including fault tolerant features) and of the internal structure of the application program;
- traceability to, and explanation of, application functions and associated constraints;
- one to one mapping between the hardware architecture and application program architecture.

## **12.5 Requirements for application program verification (review and testing)**

**12.5.1** Verification planning shall be carried out in accordance with Clause 7.

**12.5.2** The application program including its documentation shall be reviewed by a competent person not involved in the original development. The approach used for the review and the review results shall be documented.

**12.5.3** The application program, including its decomposition into modules if appropriate, shall be verified through review, analysis, simulation and testing techniques using written procedures and test specifications, that shall be carried out to confirm that the application program functions meet the SRS and that unintended functions are not executed and that there are no unintended side effects with respect to the SIF. The following shall be addressed:

- conformance to the application program design specification, the defined means and procedures, and the requirements of safety validation and test planning;
  - exercising of all parts of the application program;
  - exercising a representative range of data conditions;
  - testing for failure conditions (i.e., negative testing);
  - timing and the sequence of execution;
  - testing of communications to and from the SIS;
- NOTE Wherever feasible the communication overload condition can be verified and tested.
- integration of the off-line application program with the logic solver hardware and the underlying PE;
  - internal data flow checks to confirm that the logic solver is not just apparently working, but is working as expected;
  - when possible, integration of the application program and 3rd party devices.

**12.5.4** The mapping of the I/O data to the application program, including data type and range, shall be verified.

**12.5.5** During testing, modifications to the application program shall be subject to an impact analysis in order to determine:

- all application program parts impacted;
- the necessary re-design and re-verification activities.

**12.5.6** The results of application program testing shall be documented and include:

- the versions of the application program and its supporting documentation being tested;
- the versions of supporting software and test tools;
- names of the person(s) who performed the tests and reviews and dates;
- descriptions of the tests, reviews and dates performed;
- the test results;
- whether the objective and criteria of the tests have been met;
- if there was a failure during the test, the reasons why the failure occurred, the analysis of the failure and the records of its correction and re-test requirements.

## **12.6 Requirements for application program methodology and tools**

**12.6.1** The application program development shall comply with the constraints in the applicable safety manual(s).

NOTE The safety manual(s) can be reviewed and, if required for a specific application, additional procedures for and/or constraints on the use of methodologies and tools can be implemented.

**12.6.2** Methods, techniques and tools shall be selected and applied for each life-cycle phase so as to:

- minimize the risk of introducing faults into the application program;
- reveal and remove faults that already exist in the application program;
- ensure as far as is practicable that any faults remaining in the application program will not lead to unacceptable results;
- enhance the means of managing modifications of the application program throughout the lifetime of the SIS;
- provide evidence that the application program has the required quality.

## 13 Factory acceptance test (FAT)

### 13.1 Objective

The objective of Clause 13 is to test the devices of the SIS to ensure that the requirements defined in the SRS are met.

NOTE 1 By testing the logic solver, associated software and hardware prior to installation, errors can be readily identified and corrected.

NOTE 2 The FAT is sometimes referred to as an integration test and can be part of the validation.

NOTE 3 Testing of field elements together with the logic solver can be recommended when there needs to be a high confidence in operation prior to final installation, e.g., subsea applications.

### 13.2 Recommendations

**13.2.1** The need for a FAT shall be specified during the safety planning for a project.

NOTE 1 Close co-operation between the logic solver supplier and design contractor can be required in order to develop the integration tests.

NOTE 2 The activities follow the design and development phases and precede the installation and commissioning.

NOTE 3 The activities are applicable to the SIS subsystems with or without programmable electronics.

NOTE 4 It is usual for the FAT to take place in a factory environment prior to installation and commissioning in the plant.

**13.2.2** The planning for a FAT shall specify the following:

- Types of tests to be performed including black-box system functionality tests; performance tests; internal checks; performance tests; environmental tests; interface testing; testing in degraded or faulted condition; exception testing; testing for safe reaction in case of power failure (including restart after power restored); and application of the SIS maintenance and operating manuals;

NOTE 1 Black-box functionality testing is a test design method that treats the system as a “black box”, so it does not explicitly use knowledge of its internal structure. Black-box test design is usually described as focusing on testing function requirements. Synonyms for black box include behavioural, functional, opaque-box, and closed-box testing.

NOTE 2 Performance tests determine whether the system meets timing, reliability and availability, integrity, safety targets and constraints.

NOTE 3 Environmental tests include EMC, life-and stress-testing.

NOTE 4 Internal data flow checks can be carried out to that the SIS is processing input data and generating output response as specified.

- Test cases, test description and test data;

NOTE 5 Clarity in defining who is responsible for developing the test case and who is going to be responsible for carrying out the test and witnessing the test can be very important.

- Dependence on other systems/interfaces;
- Test environment and tools;
- Logic solver, sensor and final element configuration;
- Test criteria on which the completion of the test shall be judged;
- Procedures for corrective action on failure of test;
- Test personnel competences;
- Physical location;
- Hazards posed by the testing especially dealing with stored energy;
- A clear diagram of the test-set up.
- Recording of tests conducted, data, results and observations whilst the tests are being conducted.

NOTE 6 Tests that cannot be physically demonstrated are normally resolved by a formal line of reasoning as to why the SIS achieves the requirement, target or constraint.

**13.2.3** The FAT shall take place on a defined version of the logic solver.

**13.2.4** The FAT shall be conducted in accordance with the FAT planning. These tests shall show that all the logic performs correctly.

**13.2.5** For each test carried out the following shall be addressed:

- the version of the test planning being used;
- the SIF and performance characteristic being tested;
- the detailed test procedures and test descriptions;
- a chronological record of the test activities;
- the tools, equipment and interfaces used.

**13.2.6** The results of FAT shall be documented, stating

- the test cases;
- the test results;
- whether the objectives and test criteria have been met.

If there is a failure during test, the reasons for the failure shall be documented and analysed and the appropriate corrective action should be implemented.

**13.2.7** During FAT, any modification or change shall be subject to a safety analysis to determine:

- the extent of impact on each SIF;
- the extent of testing and verification which shall be defined and implemented.

NOTE Commissioning can commence whilst corrective action is undertaken, depending on the results of the FAT.

## **14 SIS installation and commissioning**

### **14.1 Objectives**

The objectives of the requirements of Clause 14 are to:

- install the SIS according to the specifications and drawings;
- commission the SIS so that it is ready for final system validation.

NOTE The purpose of commissioning activities is to ensure that each of the SIS devices is individually ready to operate, as specified in the design phase.

### **14.2 Requirements**

**14.2.1** Installation and commissioning planning shall define all activities required for installation and commissioning. The planning shall provide the following:

- the installation and commissioning activities;
- the procedures, measures and techniques to be used for installation and commissioning;
- when these activities shall take place;
- the persons, departments and organizations responsible for these activities.

Installation and commissioning planning may be integrated in the overall project planning where appropriate.

**14.2.2** All SIS devices shall be properly installed according to the design and installation plan(s).

**14.2.3** The SIS shall be commissioned in accordance with planning in preparation for the final system validation. Commissioning activities shall include, but not be limited to, confirmation of the following:

- earthing (grounding) has been properly connected;
- energy sources have been properly connected and are operational;
- transportation stops and packing materials have been removed;
- no physical damage is present;
- all instruments have been properly calibrated and configured;
- all field devices are operational;
- logic solver and input/outputs are operational;
- the interfaces to other systems and peripherals are operational;
- all communications between remote SIS systems are operational.

**14.2.4** Appropriate records of the commissioning of the SIS shall be produced, stating the results of the activities and whether the objectives and criteria identified during the design phase have been met. If there is a failure, the reasons for the failure shall be recorded.

**14.2.5** Where it has been established that the actual installation does not conform to the design information then the difference shall be evaluated by a competent person and impact of the difference on safety shall be determined. If it is established that the difference has no impact on safety, then the design information shall be updated to “as-built” status. If the difference has a negative impact on safety, then the installation shall be modified to meet the design requirements.

## **15 SIS safety validation**

### **15.1 Objective**

The objective of the requirements of Clause 15 is to validate, through inspection and testing, that the installed and commissioned SIS and its associated SIF(s) achieve the requirements as stated in the SRS.

NOTE This is sometimes referred to as a site acceptance test (SAT).

### **15.2 Requirements**

**15.2.1** Validation planning of the SIS shall be carried out throughout the SIS safety life-cycle and shall define all activities and equipment required for validation. The following items shall be included:

- the validation activities including validation of the SIS with respect to the SRS including implementation and resolution of resulting recommendations;
- validation of all relevant process operating modes of the process and its associated equipment including;
  - preparation for use including setting and adjustment;
  - start-up, automatic, manual, semi-automatic, steady state of operation;
  - re-setting, shutdown, maintenance;
  - other modes identified in previous phases of the SIS safety life-cycle;



- the procedures, measures and techniques to be used for validation, including how validation activities can be performed, without putting the plant and process at risk of the hazardous events the SIS is to protect against;
- when these activities shall take place;
- the persons, departments and organizations responsible for these activities and the levels of independence for validation activities;
- reference to information against which validation shall be carried out (e.g., cause and effect chart);
- the equipment and facilities that needs to be installed or made available (e.g. isolation valves and leak detection equipment that will be needed for the testing of valves).

NOTE Examples of validation activities include loop testing, logic testing, calibration procedures, simulation of application program.

**15.2.2** Validation planning for the application program shall include the following:

- identification of the application program functions which needs to be validated for each process operating mode before commissioning begins;
- the technical strategy for the validation including (where relevant):
  - manual and automated techniques;
  - static and dynamic techniques;
  - analytical and statistical techniques.
- in accordance with item “b” above, the measures (techniques) and procedures that will be used for confirming that each SIF conforms with the specified safety requirements and the specified SIL;
- the required environment in which the validation activities are to take place (e.g., for tests this would include calibrated tools and equipment);
- the application program;
- the pass/fail criteria for accomplishing validation including:
  - the required process and operator input signals with their sequences and their values;
  - the anticipated output signals with their sequences and their values;
  - other acceptance criteria, for example memory usage, timing and value tolerances.
- the policies and procedures for evaluating the results of the validation, particularly failures;
- all documents (see Clause 19) are validated for accuracy, consistency and traceability of the SIF from inception during the H&RA through the final installed SIF.

**15.2.3** Where measurement accuracy is required as part of the validation then instruments used for this function should be calibrated against a specification traceable to a standard within an uncertainty appropriate to the application. If such a calibration is not feasible, an alternative method shall be used and documented.

**15.2.4** The validation of the SIS and its associated SIF(s) shall be carried out in accordance with the SIS validation planning. Validation activities shall include, but not be limited to, the following:

- confirmation that the SIS performs under normal and abnormal process operating modes (e.g., start-up, shutdown) as identified in the SRS;
- confirmation that adverse interaction of the BPCS and other connected systems do not affect the proper operation of the SIS;
- the SIS properly communicates (where required) with the BPCS or any other system or network, including during abnormal conditions such as a data overload;

- sensors, logic solver, and final elements perform in accordance with the SRS, including all redundant channels, including abnormal condition such as data overload;

NOTE If a factory acceptance test (FAT) was performed on the logic solver as described in Clause 13, credit can be taken for validation of the logic solver by the FAT. After all equipment is installed in the plant, full loop validation will test the logic solver functionality and its connections to other SIS subsystems.

- SIS design documentation is consistent with the installed system;
- confirmation that the SIF performs as specified on invalid process variable values (e.g., out of range);
- the proper shutdown sequence is activated;
- the SIS provides the proper annunciation and proper operation display;
- computations that are included in the SIS are correct for expected range of values but also at limits and over the limits;
- the SIS reset functions perform as defined in the SRS;
- bypass functions operate correctly;
- start-up overrides operate correctly;
- manual shutdown systems operate correctly;
- the proof-test policy documented in the maintenance procedures;
- diagnostic alarm functions perform as required;
- confirmation that the SIS performs as required on loss of utilities (e.g., electrical power, air, hydraulics) and confirmation that, when the utilities are restored, the SIS returns to the desired state;
- confirmation that the EMC immunity, as specified in the SRS (see 10.3), has been achieved.

**15.2.5** The validation of the application program shall determine whether:

- all of the specified application program safety requirements (see 10.3.2) are correctly performed;
- the application program does not jeopardize the safety requirements under SIS fault conditions and in degraded modes of operation and for BPCS fault conditions for any interfaces between the SIS and BPCS;
- the application program does not jeopardize the safety requirements by executing “unused” software functionality, i.e., functionality not defined in the specification.

The information of the validation activities shall be available.

**15.2.6** The results from the validation plan activities shall represent and cover the entire SIS validation process. SIS validation documentation shall be produced which provides:

- the version of the SIS validation planning being used;
- the SIF(s) under test (or analysis), along with the specific reference to the requirement identified during the SIS validation planning;
- tools and equipment used, along with their calibration data;
- the results of each test;
- the version of the test specification used;
- the criteria for acceptance of the completed tests;
- the version of the SIS hardware, application program(s), and other software being tested;
- any discrepancy between expected and actual results and the resolution of that discrepancy;

- the analysis made and the decisions taken on whether to continue the test or to issue a change request, in the case where discrepancies occur.

**15.2.7** The results shall be verified against the expected results. All discrepancies shall be analysed and the findings shall be available as part of the validation documentation. This shall include the analysis made and the decisions taken on whether to continue the validation or to issue a change request and to return to an earlier part of the development life-cycle.

**15.2.8** After the SIS validation and prior to the identified hazards being present, the following activities shall be carried out:

- all bypass functions (e.g., PE logic solver and PE sensor forces, disabled alarms) shall be returned to their normal position;
- all process isolation valves shall be set according to the process start-up requirements and procedures;
- all test materials (e.g., fluids) shall be removed;
- all commissioning overrides and force permissives shall be removed.

## **16 SIS operation and maintenance**

### **16.1 Objectives**

The objectives of the requirements of Clause 16 are to ensure that:

- the required SIL of each SIF is maintained during operation and maintenance;
- the SIS is operated and maintained in a way that sustains the required safety integrity.

### **16.2 Requirements**

**16.2.1** Operation and maintenance planning for the SIS shall be carried out. It shall provide the following:

- routine and abnormal operation activities;
- inspection, proof testing, preventive and breakdown maintenance activities;
- the procedures, measures and techniques to be used for operation and maintenance;
- the operational response to faults and failures identified by diagnostics, inspections or proof-tests;
- verification of conformity to operations and maintenance procedures;
- when these activities shall take place;
- the persons, departments and organizations responsible for these activities;
- a SIS maintenance plan.

NOTE The SIS maintenance plan can state different maintenance features depending on the SIL level.

**16.2.2** Operation and maintenance procedures shall be developed in accordance with the relevant safety planning and shall provide the following:

- a) the routine methods and procedures which need to be carried out to maintain the "as designed" functional safety of the SIS;
- b) the procedures used to ensure the quality and consistency of proof testing, and to ensure adequate validation is being performed after replacement of any device;
- c) the measures and constraints that are necessary to prevent an unsafe state and/or reduce the consequences of a hazardous event during maintenance or operation (e.g., when a system needs to be bypassed for testing or maintenance, what additional risk reduction needs to be implemented);
- d) the methods and procedures which are used to test the diagnostics;

- e) the information which needs to be maintained on SIS failure and the demand rates on the SIS;
- f) procedures for collecting data related to the demand rate and SIS reliability parameters;

NOTE 1 Collection and analysis of failure data has many benefits including the potential to reduce maintenance costs if failures rates in operation are significantly lower than what were predicted during design. Implementation costs of new installations can also be reduced because new designs can be based on less conservative failure rates.

- g) the information which needs to be maintained showing results of audits and tests on the SIS;
- h) the maintenance procedures to be followed when faults or failures occur in the SIS, including:
  - procedures for fault diagnostics and repair;
  - procedures for revalidation;
  - maintenance reporting requirements;
  - procedures for tracking maintenance performance.

NOTE 2 Considerations include:

- procedures for reporting failures;
- procedures for analysing systematic failures;
- the actions to allow safe shutdown in the event of BPCS failure;
- ensuring that test equipment is properly calibrated and maintained.

**16.2.3** Operation procedures shall be made available. Compensating measures that ensure continued safety while the SIS is disabled or degraded due to bypass (repair or testing) shall be applied with the associated operation limits (duration, process parameters, etc.). The operator shall be provided with information on the procedures to be applied before and during bypass and what should be done before the removal of the bypass and the maximum time allowed to be in the bypass state. This information shall be reviewed on a regular basis.

NOTE The operating and maintenance procedures can include verification that bypasses are removed after proof testing.

**16.2.4** Continued process operation with a SIS device in bypass shall only be permitted if a hazards analysis has determined that compensating measures are in place and that they provide adequate risk reduction. Operating procedures shall be developed accordingly.

**16.2.5** Operation and maintenance shall proceed in accordance with the relevant procedures.

**16.2.6** Operators shall be trained on the function and operation of the SIS in their area. This training shall ensure that they understand:

- how the SIS functions (trip points and the resulting action that is taken by the SIS);
 

NOTE 1 This can also include impact of an SIS action to remaining operational plant.
- the hazard the SIS is protecting against;
- the correct operation and management of all bypass/override switches and under what circumstances these bypasses are to be used;
- the operation of any manual shutdown switches and manual start-up activity and when these manual switches are to be activated;
 

NOTE 2 This can include “system reset” and “system restart”.
- expectation on activation of any diagnostic alarms (e.g., what action shall be taken when any SIS alarm is activated indicating there is a problem with the SIS);
- the proper verification of the diagnostics.

**16.2.7** The status of all bypasses shall be recorded in a bypass log. All bypasses need authorization and indication.

**16.2.8** Maintenance personnel shall be trained as required to sustain full functional performance of the SIS (hardware and software) to meet the target SIL of each SIF.

**16.2.9** Discrepancies between expected behaviour and actual behaviour of the SIS shall be analysed and, where necessary, modifications made such that the required safety is maintained. This shall include monitoring the following:

- the demand rate on each SIF (see 5.2.5.3);
- the actions taken following a demand on the system;
- the failures and failure modes of equipment forming part of the SIS, including those identified during normal operation, inspection, testing or demand on a SIF;
- the cause of the demands;
- the cause and frequency of spurious trips;
- the failure of equipment forming part of any compensating measures.

**16.2.10** The operation and maintenance procedures may require revision, if necessary, following:

- functional safety audits;
- tests on the SIS;
- experience from normal or abnormal operation and maintenance events.

**16.2.11** Written proof-test procedures shall be developed for every SIF to reveal dangerous failures undetected by diagnostics. These written test procedures shall describe every step that is to be performed and shall include:

- the correct operation of each sensor and final element;
- correct logic action;
- correct alarms and indications.

NOTE The following methods can be used to determine the undetected failures that need to be tested:

- examination of fault trees;
- failure mode and effect analysis;
- reliability centred maintenance.

**16.2.12** SIS spare parts shall be identified and shall be made available to minimize the bypass duration due to unavailability of any replacement part for the SIS.

NOTE Replacements that are not in kind (like for like) can be managed as a modification to the SIS.

**16.2.13** Persons responsible for operations and maintenance shall review the hazard and risk analysis, allocation and design to ensure the assumptions made are valid e.g. assumptions on occupancy and corrosion protection.

## **16.3 Proof testing and inspection**

### **16.3.1 Proof testing**

**16.3.1.1** Periodic proof tests shall be conducted using a written procedure to reveal undetected faults that prevent the SIS from operating in accordance with the SRS.

NOTE 1 Particular attention can be made to identify failure causes that may lead to common cause failures.

NOTE 2 Functional test procedures can also emphasize the need to avoid introducing common cause failures.

**16.3.1.2** The entire SIS shall be tested including the sensor(s), the logic solver and the final element(s) (e.g., shutdown valves and motors).

NOTE Testing of the SIS can be performed either end-to-end or in segments (see 11.8.1).

**16.3.1.3** The schedule for the proof tests shall be according to the SRS. The frequency of proof tests for a SIF shall be determined through  $PFD_{avg}$  or PFH calculation in accordance with 11.9 for the SIS as installed in the operating environment.

NOTE Different parts of the SIS can require different test intervals, for example, the logic solver can require a different test interval than the sensors or final elements.

**16.3.1.4** Any deficiencies found during the proof testing shall be repaired in a safe and timely manner. A proof test shall be repeated after the repair is completed.

**16.3.1.5** At some periodic interval (determined by the user), the frequency of testing shall be re-evaluated based on various factors including historical test data, plant experience and hardware degradation.

NOTE The user can adjust the test frequency based on this data and an analysis of the original basis for test frequency.

**16.3.1.6** Any change to the application program requires full validation and a proof test of any SIF impacted by the change. Exceptions to this are allowed if appropriate review and partial testing of changes are carried out to ensure the changes were designed per the updated safety requirements and correctly implemented.

**16.3.1.7** Suitable management procedures shall be applied to review deferrals and prevent significant delay to proof testing.

## **16.3.2 Inspection**

Each SIS shall be periodically visually inspected to ensure there are no unauthorized modifications and no observable deterioration (e.g., missing bolts or instrument covers, rusted brackets, open wires, broken conduits, broken heat tracing, and missing insulation).

NOTE These problems could indicate an increase in the frequency of faults.

## **16.3.3 Documentation of proof tests and inspection**

The user shall maintain records that certify that proof tests and inspections were completed as required. These records shall include the following information as a minimum:

- a) description of the tests and inspections performed including identification of the test procedure used;
- b) dates of the tests and inspections;
- c) name of the person(s) who performed the tests and inspections;
- d) serial number or other unique identifier of the system tested (e.g., loop number, tag number, equipment number, and SIF number);
- e) results of the tests and inspection including the "as-found" condition, all faults found (including the failure mode) and the "as-left" condition.

## **17 SIS modification**

### **17.1 Objectives**

The objectives of the requirements of Clause 17 are:

- that modifications to any SIS are properly planned, reviewed, approved and documented prior to making the change;
- to ensure that the required safety integrity of the SIS is maintained despite of any changes made to the SIS.

NOTE Modifications to the BPCS, other equipment, process or operating conditions can be reviewed to determine whether they are such that the nature or frequency of demands on the SIS will be affected. Those having an adverse effect can be considered further to determine whether the level of risk reduction will still be sufficient.

## 17.2 Requirements

**17.2.1** Prior to carrying out any modification to a SIS, procedures for authorizing and controlling changes shall be in place.

**17.2.2** The procedures shall include a clear method of identifying and requesting the work to be done and the hazards that may be affected.

**17.2.3** Prior to carrying out any modification to a SIS (including the application program) an analysis shall be carried out to determine the impact on functional safety as a result of the proposed modification. When the analysis shows that the proposed modification could impact safety then there shall be a return to the first phase of the SIS safety life-cycle affected by the modification.

**17.2.4** Safety planning for the modification and re-verification shall be available. Modifications and re-verifications shall be carried out in accordance with the planning.

**17.2.5** All documentation affected by the modification shall be updated.

**17.2.6** Modification activity shall not begin until a FSA is completed in accordance with 5.2.6.1.9 and after proper authorisation.

**17.2.7** Appropriate information shall be maintained for all changes to the SIS. The information shall include:

- a description of the modification or change;
- the reason for the change;
- identified hazards and SIFs which may be affected;
- an analysis of the impact of the modification activity on the SIS;
- all approvals required for the changes;
- tests used to verify that the change was properly implemented and the SIS performs as required;
- details of all SIS modification activities (e.g., a modification log);
- appropriate configuration history;
- tests used to verify that the change has not adversely impacted parts of the SIS which were not modified.

**17.2.8** Modification shall be performed with qualified personnel who have been properly trained. All affected and appropriate personnel should be notified of the change and trained with regard to the change.

## 18 SIS decommissioning

### 18.1 Objectives

The objectives of the requirements of Clause 18 are to ensure that:

- prior to decommissioning any SIS from active service, a proper review is conducted and required authorization is obtained;
- the required SIF(s) remain operational during decommissioning activities.

## 18.2 Requirements

**18.2.1** Prior to carrying out any decommissioning of part or all of a SIS or SIF, procedures for authorizing and controlling changes shall be in place.

**18.2.2** The procedures shall include a clear method of identifying and requesting the work to be done and identifying the hazards that may be affected.

**18.2.3** An analysis shall be carried out on the impact on functional safety as a result of the proposed decommissioning activity. The assessment shall include an update of the H&RA sufficient to determine the scope of impact to the SIS safety life cycle. The subsequent SIS safety life-cycle phases shall need to be re-evaluated. The assessment shall also consider:

- functional safety during the execution of the decommissioning activities;
- the impact of decommissioning the SIS on adjacent operating units and facility services.

**18.2.4** The results of the impact analysis shall be used during safety planning to re-implement the relevant requirements of the IEC 61511 series including re-verification and re-validation.

**18.2.5** Decommissioning activities shall not begin without proper documentation and authorization.

## 19 Information and documentation requirements

### 19.1 Objectives

The objectives of the requirements of Clause 19 are to ensure that the necessary information is available and documented in order that:

- all phases of the SIS safety life-cycle can be effectively performed;
- verification, validation and FSA activities can be effectively performed.

### 19.2 Requirements

**19.2.1** The documentation required by the IEC 61511 series shall be available to personnel implementing the requirements of the IEC 61511 series.

**19.2.2** The documentation shall:

- describe the installation, system or equipment and the use of it;
- be accurate and up to date;
- be easy to understand;
- suit the purpose for which it is intended;
- be available in an accessible, maintainable and editable form, so that appropriate and relevant documents can be readily and accurately identified, located, retrieved and revised.

NOTE Further details of the requirements for information are included in Clause 14 and Clause 15.

**19.2.3** The documentation shall have unique identities so it shall be possible to reference the different parts.

**19.2.4** The documentation shall have designations indicating the type of information.

**19.2.5** The documentation shall be traceable to the functional and integrity requirements arising from this standard, including the H&RA.



**19.2.6** The documentation shall have a revision index (for example, version numbers) to make it possible to identify different versions of the information.

**19.2.7** The documentation shall be structured to make it possible to search for relevant information. It shall be possible to identify the latest revision (version) of a document.

NOTE The physical structure of the documentation can vary depending upon a number of factors such as the size of the system, its complexity and the organizational requirements.

**19.2.8** All relevant documentation shall be revised, amended, reviewed, approved and shall be under the control of an appropriate information control scheme.

**19.2.9** Current documentation pertaining to the following shall be maintained:

- a) the results of the H&RA and the related assumptions;
- b) the equipment used for SIF together with its safety requirements;
- c) the organization responsible for maintaining functional safety;
- d) the procedures necessary to achieve and maintain functional safety of the SIS;
- e) the modification information as defined in 17.2.5;
- f) the safety manual(s);
- g) design, implementation, test and validation.

NOTE Further details of the requirements for information are included in 12.4.2, Clauses 14 and 15 and in 16.3.3.

## Bibliography

IEC 60050 (all parts), *International Electrotechnical Vocabulary* (available at <http://www.electropedia.org/>)

ISO/IEC Guide 51:2014, *Safety aspects – Guidelines for their inclusion in standards*

IEC 60300-3-2:2004, *Dependability management – Part 3-2: Application guide – Collection of dependability data from the field*

IEC 60605-4:2001, *Equipment reliability testing – Part 4: Statistical procedures for exponential distribution – Point estimates, confidence intervals, prediction intervals and tolerance intervals*

IEC 60617-12:1997, *Graphical symbols for diagrams – Part 12: Binary logic elements*<sup>1</sup>

IEC TS 61000-1-2:2008, *Electromagnetic compatibility (EMC) – Part 1-2: General – Methodology for the achievement of functional safety of electrical and electronic systems including equipment with regard to electromagnetic phenomena*

IEC 61025, *Fault tree analysis (FTA)*

IEC 61131-3:2013, *Programmable controllers – Part 3: Programming language*

IEC 61131-6:2012, *Programmable controllers – Part 6: Functional Safety*

IEC 61506:1997, *Industrial-process measurement and control – Documentation of application software*

IEC 61508-4:2010, *Functional safety of electrical/electronic/programmable electronic safety related systems – Part 4: Definitions and abbreviations*

IEC 61508-6:2010, *Functional safety of electrical/electronic/programmable electronic safety related systems – Part 6: Guidelines on the application of IEC 61508-2 and IEC 61508-3*

IEC 61511-2:\_\_\_, *Functional safety – Safety instrumented systems for the process industry sector – Part 2: Guidelines for the application of IEC 61511-1*

IEC 61511-3:\_\_\_, *Functional safety – Safety instrumented systems for the process industry sector – Part 3: Guidance for the determination of the required safety integrity levels*

IEC 61784-3:2010, *Industrial communication networks – Profiles – Part 3: Functional safety fieldbuses – General rules and profile definitions*

IEC 62443-2-1:2010, *Industrial communication networks – Network and system security – Part 2-1: Establishing an industrial automation and control system security program*

IEC 62682:2014, *Management of alarms for the process industry*

ISO/IEC 2382:2006, *Information technology – Vocabulary*

ISO/IEC 27001:2013, *Information technology – Security techniques – Information security management systems – Requirements*

---

<sup>1</sup> Withdrawn.

ISO/IEC 90003:2014, *Software engineering – Part 3: Guidelines for the application of ISO 9001:2000 to computer software*

ISO 2382-1:1993, *Information technology – Vocabulary – Part 1: Fundamental terms*

ISO 9000:2005, *Quality management systems – Fundamentals and vocabulary*

ISO 9001:2008, *Quality management systems – Requirements*

ISO TR 12489:2013, *Petroleum, petrochemical and natural gas industries – Reliability modelling and calculation of safety systems*

ISO 13849-1:2006, *Safety of machinery – Safety related parts of control systems – Part 1: General principles for design*

ISO 13849-2:2012, *Safety of machinery – Safety related parts of control systems – Part 2: Validation*

ISO 14224:2006, *Petroleum, petrochemical and natural gas industries- Collection and exchange of reliability and maintenance of data for equipment*

ISA TR 84.00.04 Part 1:2015, *Guidelines on the Implementation of ANSI/ISA-84.00.01-2004 (IEC 61511)*

ISA TR 84.00.09:2013, *Security Countermeasures Related to Safety Instrumented Systems (SIS)*

---





INTERNATIONAL  
ELECTROTECHNICAL  
COMMISSION

3, rue de Varembé  
PO Box 131  
CH-1211 Geneva 20  
Switzerland

Tel: + 41 22 919 02 11  
Fax: + 41 22 919 03 00  
[info@iec.ch](mailto:info@iec.ch)  
[www.iec.ch](http://www.iec.ch)