

洁净室围护系统解决方案

智慧设计 环境友好 智能交付



WISKIND

万事达：刘世林

时间：2020/9/28



WISKIND

关于万事达

About Wiskind

- 总体介绍
- 发展历程
- 公司荣誉
- 专业团队
- 服务网络
- 服务领域
- 公司实力



关于万事达



3 大产业板块
1 个中心
41 年创新发展历史
27 个细分行业解决方案
1,800 名专业员工团队
500 强企业认可品牌
1.6 亿平方米建筑产品供货量
1,000 多亩先进智能制造中心
100 亿元年销售额 (2019)



三大板块贯通产业链上下游



冷轧钢板

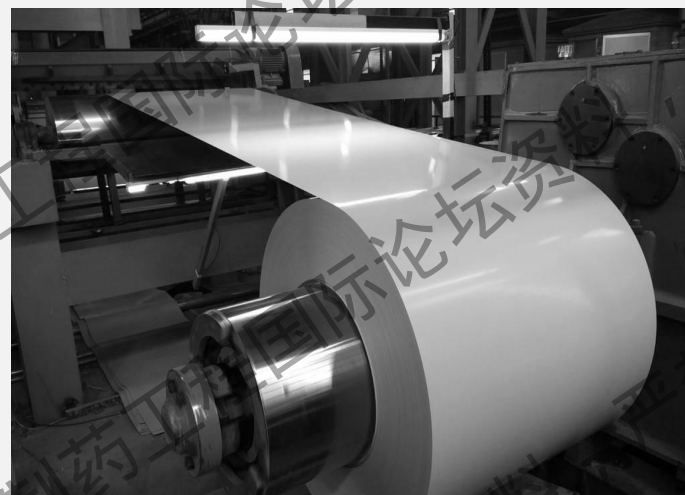

涂镀应用



建筑钢品

始于1978 从工匠到匠心



1978-1999

- 1970s 早期为钣金加工作坊。
- 1980s 从事热浸镀锌钢板贸易和加工，成为行业先驱。
- 1993 万事达公司成立。带领同行建设北方最大涂镀钢板贸易市场。
- 1997 进入建筑钢品制造领域。

2000-2009

- 2000 建成首条复合板生产线
- 2003 万事达建筑钢品研发中心成立。
- 2007 推出丽彩®系列聚氨酯产品。取得中国钢结构制造企业一级资质。
- 2009 获得国家高新技术企业认定。参建上海世博会德国馆项目。

2010-至今

- 2010 推出新型手工洁净板。新美达冷轧一期建成，涉足冷轧钢板行业。
- 2013 RSS486型屋面系统获美国FM认证。
- 2014 万事达建筑钢品股份公司在“新三板”挂牌。
- 2015 新型保温幕墙产品丽彩幕®上市。
- 2016 业内首条洁净板自动生产线投产。钢品研究院成立。
- 2018 冷库板新产线创多项行业之最。参建青岛国际会议中心等标志性建筑。

资质和荣誉

专业资质 ISO9001质量管理体系双认证企业
ISO14001环境管理体系认证企业
OHSAS18001职业健康安全管理体系认证证书
SGS国际认证
CE国际认证
FM国际认证

企业荣誉 国家高新技术企业
山东省级认定企业技术中心
中国医药工程设计协会会员单位
中国医药设备工程协会理事单位
中国制药装备行业协会会员单位
中国电子学会洁净技术分会会员单位
中国中央厨房产业技术创新战略联盟企业
美国IEST会员企业



专业团队



技术人才超60名
资深行业专家



严谨，高标准要求
先进的管理体系



资深、专业
更细致的行业分类



稳定、高效的
服务团队

服务网络

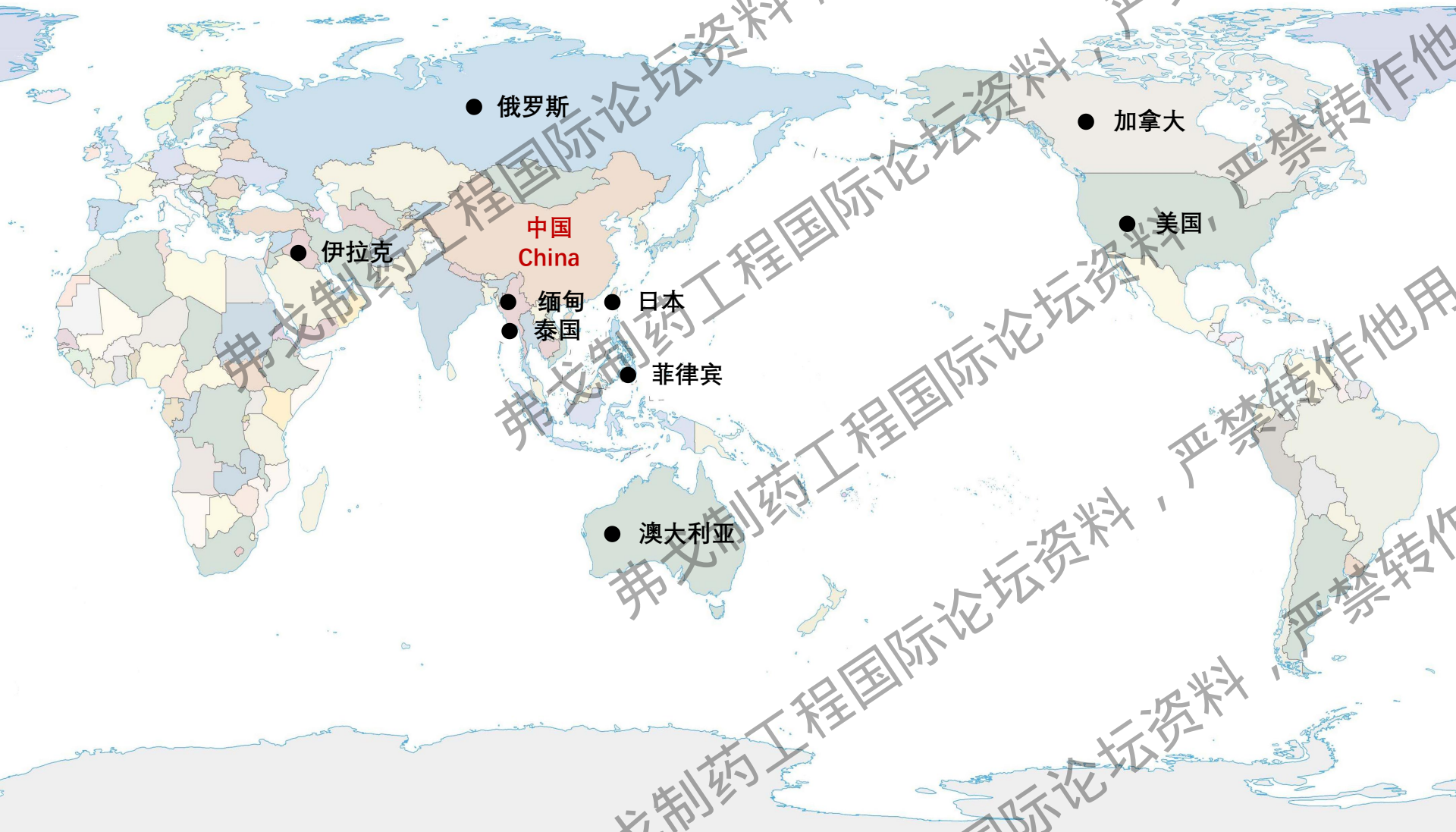

服务全球

服务领域



WISKIND



生物医药



食品安全



中央厨房



医院

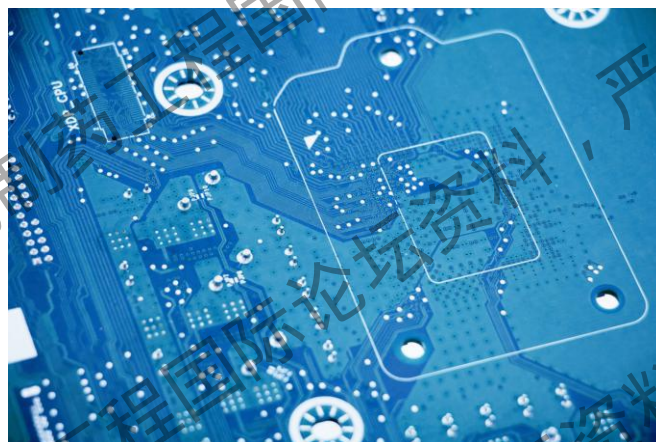

半导体/面板



航空航天

公司实力



全球首条洁净板自动化生产线

行业最先进的实验室

行业最强研发团队

行业最专业的洁净室围护系统服务商

行业最全面的解决方案

行业最完善的服务体系

.....



WISKIND

洁净室围护系统解决方案

Cleanroom Enclosure System Solution

- 模块化
- 功能集成化
- 智慧设计
- 环境友好
- 智能交付





WISKIND

模块化

一体转角板

可拆卸板

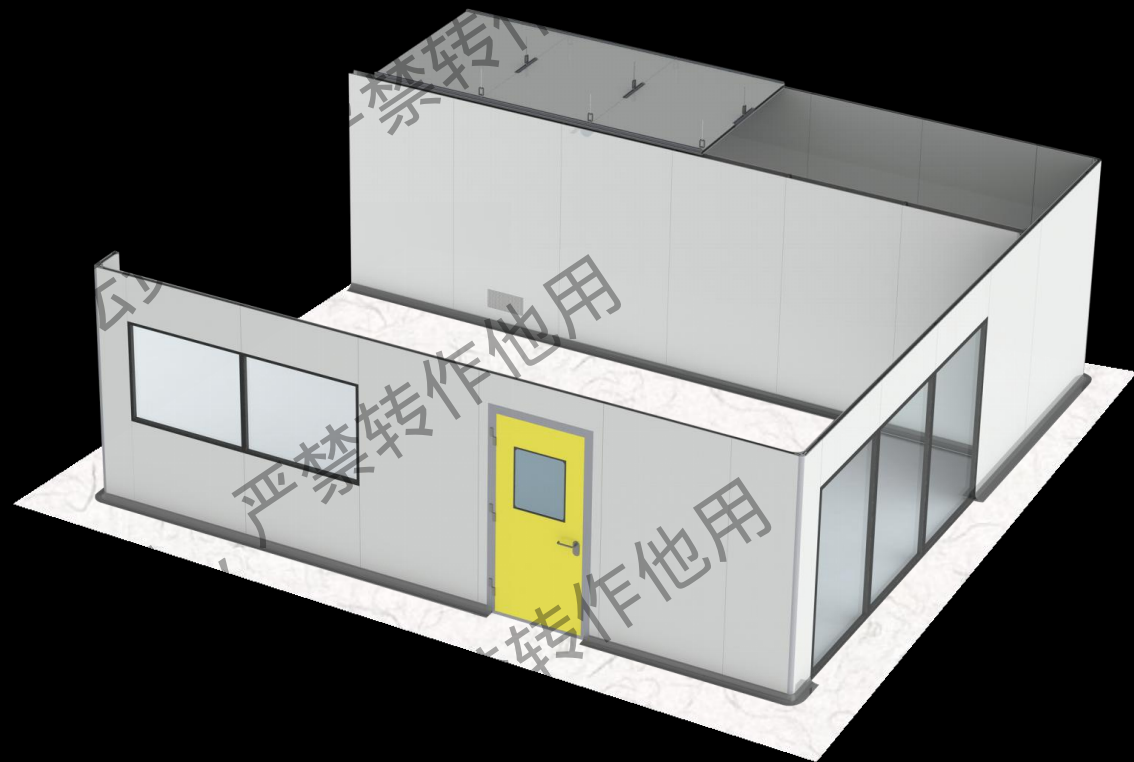



一体转角板

ONE PIECE CORNER PANEL

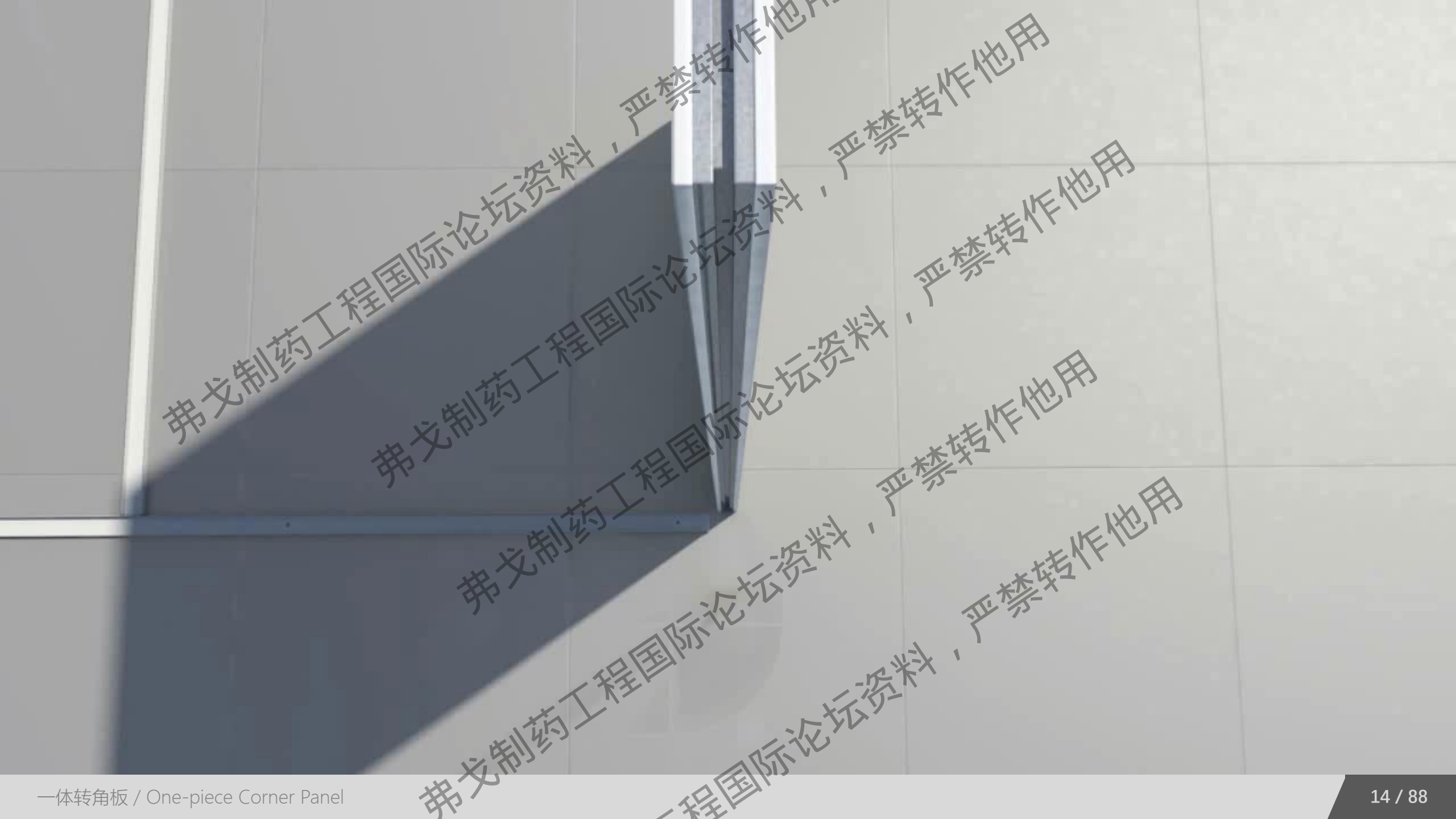

弗戈制药工程国际论坛资料，严禁转作他用

弗戈制药工程国际论坛资料，严禁转作他用

弗戈制药工程国际论坛资料，严禁转作他用

弗戈制药工程国际论坛资料，严禁转作他用

弗戈制药工程国际论坛资料，严禁转作他用

弗戈制药工程国际论坛资料，严禁转作他用

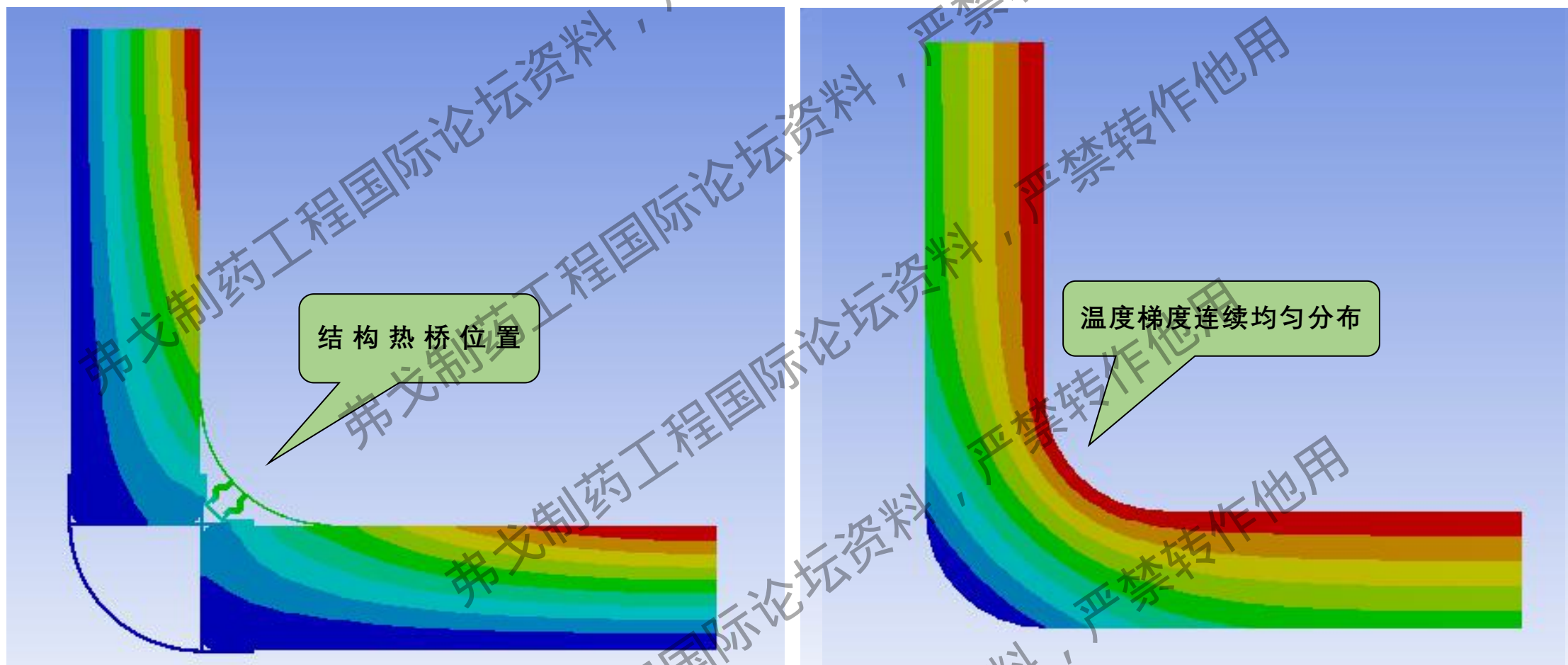



WISKIND



直角一体转角板

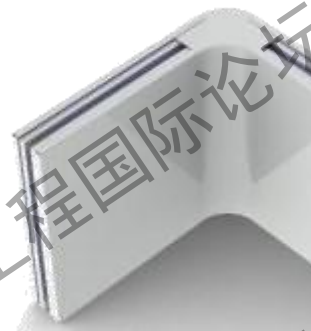

圆弧一体转



T型一体转角板

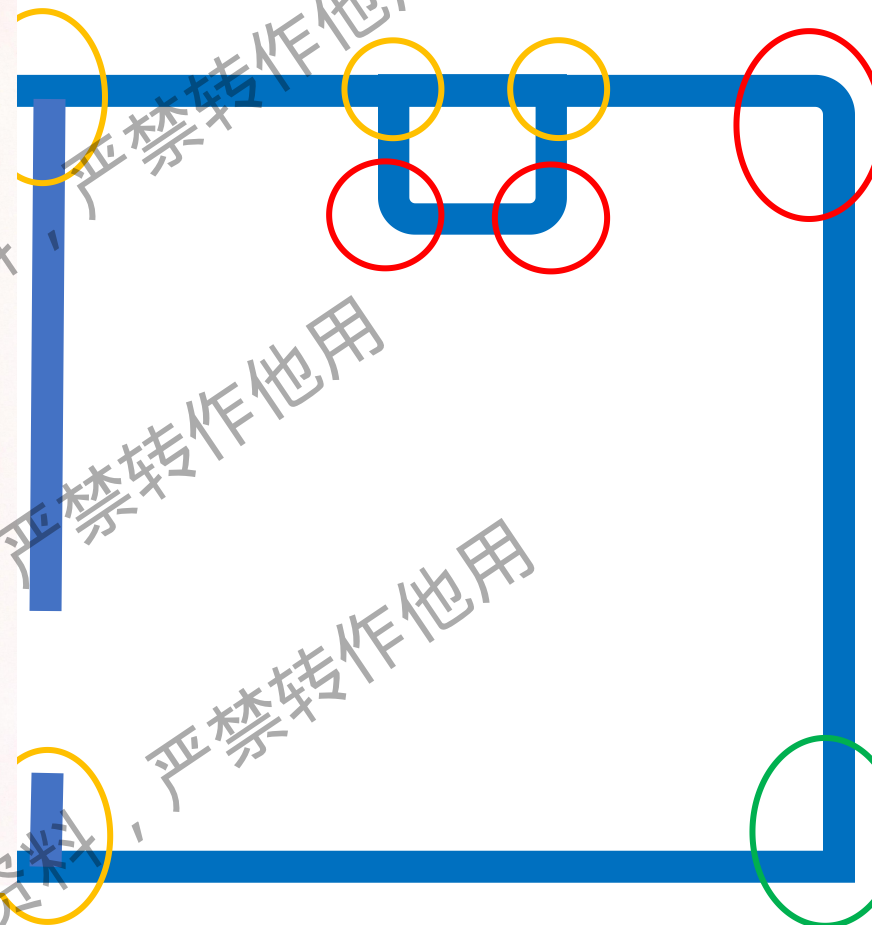
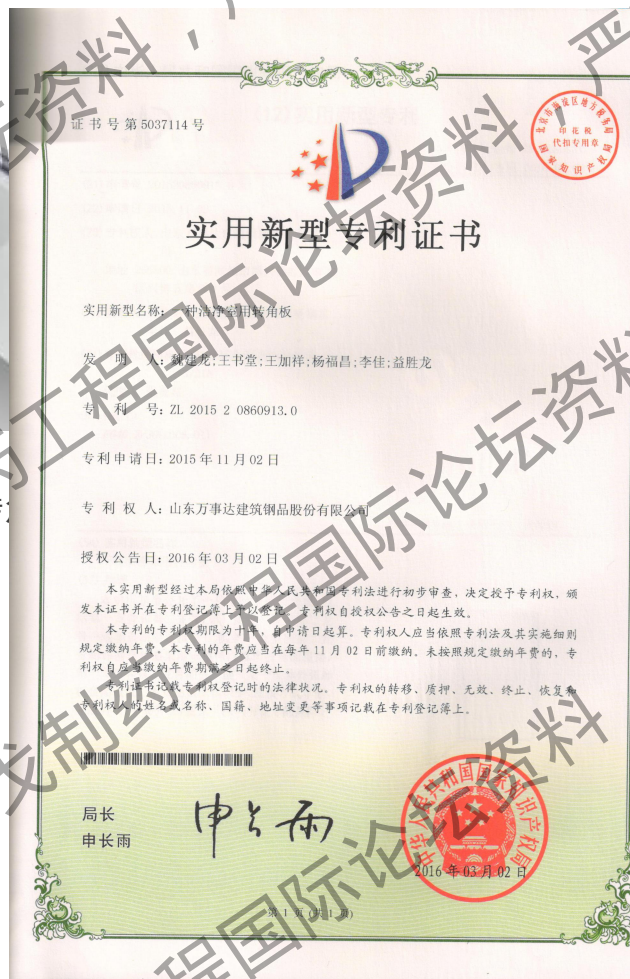



GMP第四十九条

- 洁净区的内表面（墙壁、地面、天棚）应当平整光滑；
- 无裂缝、接口严密、无颗粒物脱落，避免积尘；
- 便于有效清洁，必要时应当进行消毒。

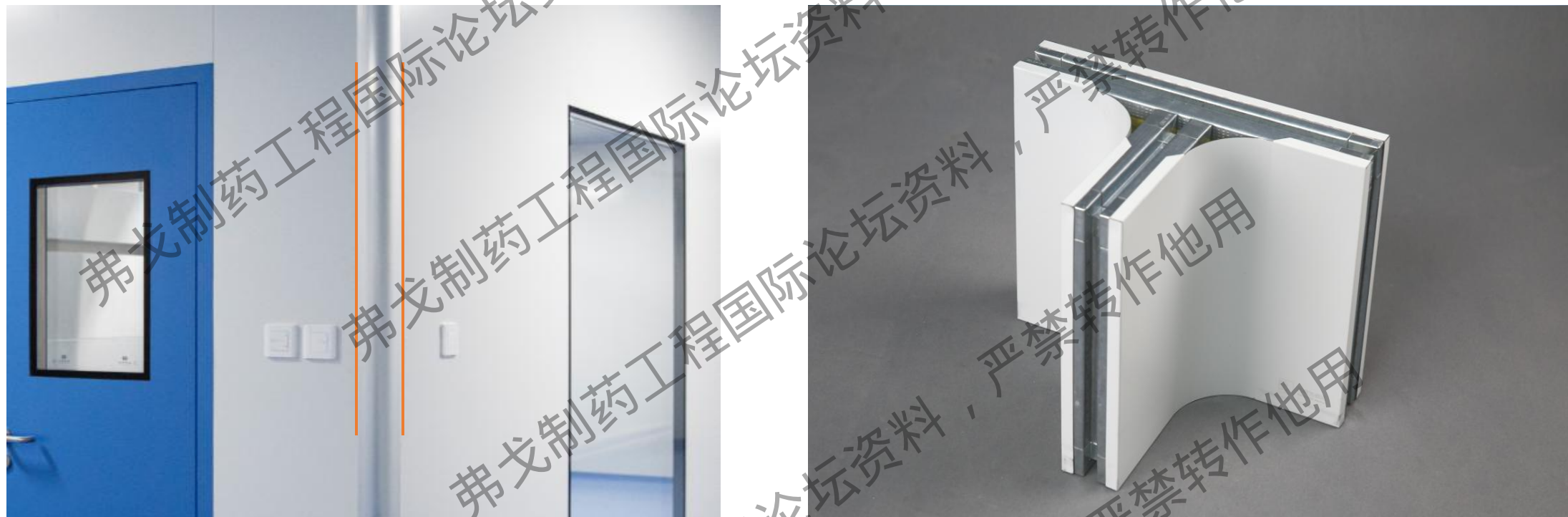



产品规格

事项	规格参数
宽度	1180mm (两边宽度和不超1180mm) 建议等边 250*250mm
最大长度	6000mm
墙体厚度	50mm
面板厚度	0.4mm-0.8mm
外板材质	彩涂钢板, 铝镁锰合金板, 不锈钢板, 钛锌板, VCM
芯材	石膏
龙骨厚度	0.6mm
适用场所	制药洁净室、电子洁净室、食品洁净室等

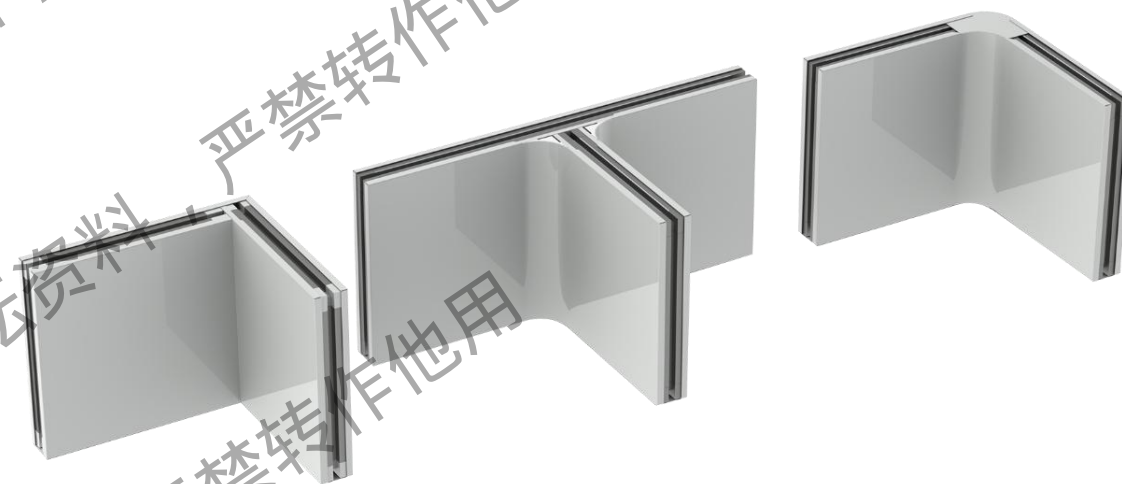

备注：此板型由洁净技术部全程跟踪，尺寸由技术部出具为准



可拆卸板

REMOVABLE PANEL



施工过程中局部损坏需要更换?

工艺设备改变布局调整?

使用过程中损坏拆除局部墙体?

.....



难题 ?



工程公司、业主

弗戈制药工程国际论坛资料，严禁转作他用

弗戈制药工程国际论坛资料，严禁转作他用

弗戈制药工程国际论坛资料，严禁转作他用

弗戈制药工程国际论坛资料，严禁转作他用

弗戈制药工程国际论坛资料，严禁转作他用

弗戈制药工程国际论坛资料，严禁转作他用



产品规格

事项	
宽度	
最大长度	
墙体厚度	50mm
面板厚度	
外板材质	彩涂钢板, 铝镁锰
芯材	岩棉, 玻镁,
龙骨厚度	
适用场所	制药洁净室

备注: 此板型由洁净

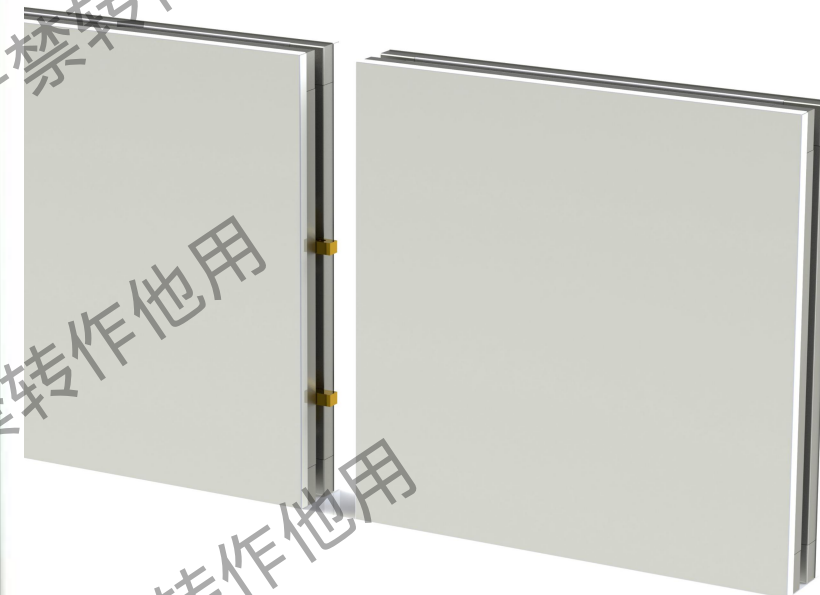



安装节点

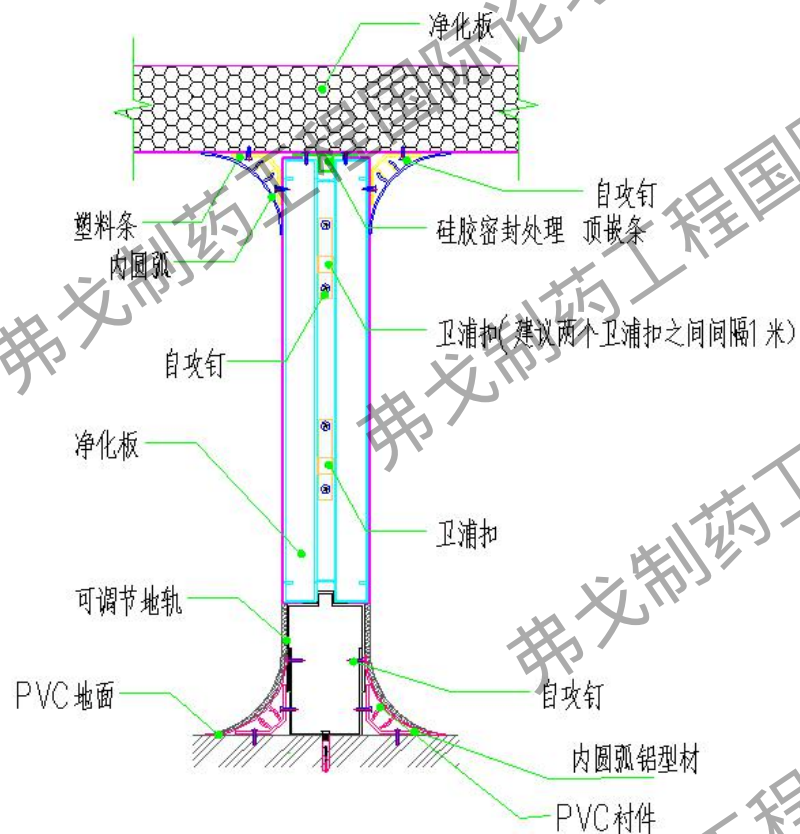



WISKIND 万事达





WISKIND

功能集成化

防冷桥龙骨

中空回风单元模块

中空回风夹道墙

大师系列洁净门

暗藏无边框门

大师系列洁净窗

洁创





弗戈制药工程国际论坛资料，严禁转作他用

弗戈制药工程国际论坛资料，严禁转作他用

防冷桥龙骨

ANTI-COLD BRIDGE CARRIER

弗戈制药工程国际论坛资料，严禁转作他用



洁净板四周由镀锌龙骨和转角组合而成，在低温洁净加工车间或寒冷季节，封边处容易发生冷~~凝~~结露现象。

冷~~凝~~结露

结露问题点

传统手工板周围采用镀锌龙骨，镀锌的导热系数为126w/m.k，就造成在所有板材连接部位形成冷桥，很容易使室内达到露点温度，从而造成室内结露。

冷桥现象

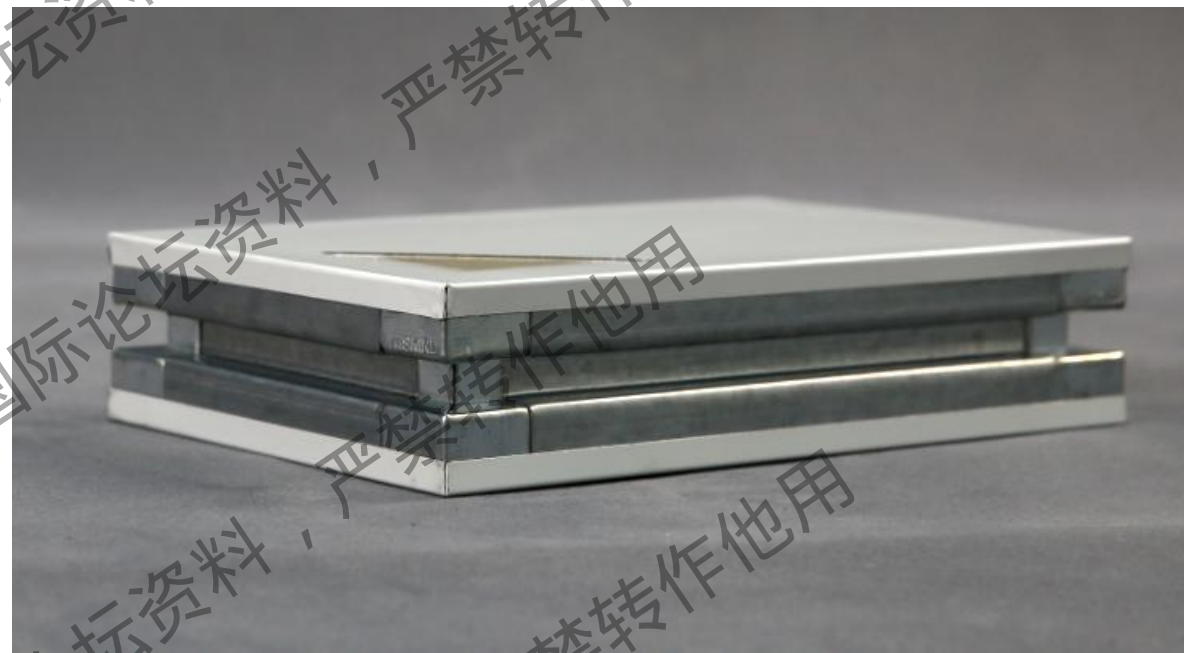

镀锌的导热系数为126w/m.k



解决问题

1. 万事达发明的断桥龙骨、隔热龙骨;
2. 提高了洁净室整体保温性能;
3. 延长了板材使用寿命, 降低更换板材成本。

降低建筑能耗

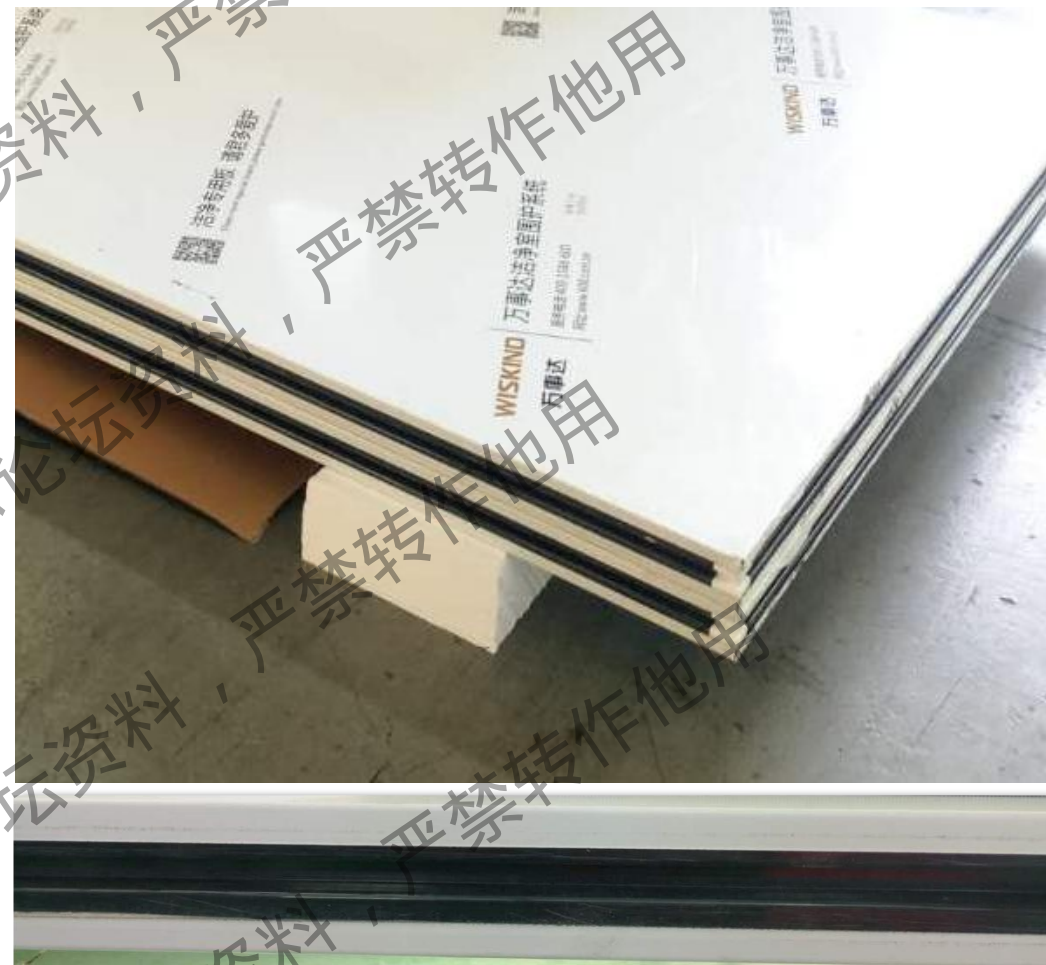

绝热龙骨导热系数 $0.14W/(m.k)$



产品规格

事项	规格参数
宽度	980mm, 1180mm
最大长度	2400mm, 3000mm
墙体厚度	50mm
面板厚度	0.4mm-0.8mm
外板材质	彩涂钢板, 铝镁锰合金板, 不锈钢板, 钛锌板, VCM
芯材	岩棉、玻镁、纸蜂窝、铝蜂窝、石膏、EPS等
龙骨厚度	1.0mm, PVC: 2.0mm
适用场所	低温高湿环境下的洁净车间

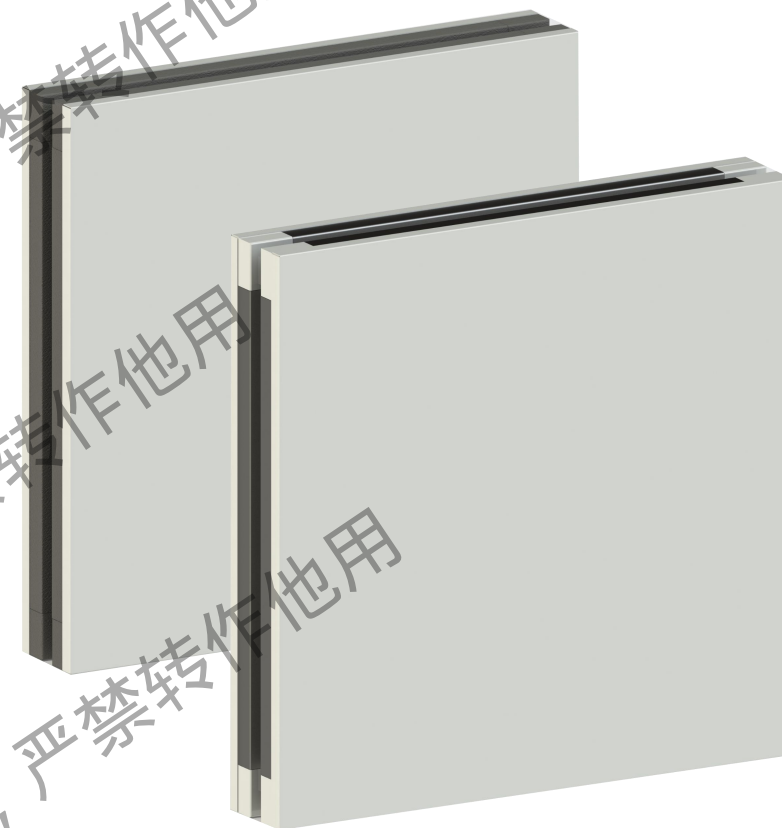

备注：此板型由洁净技术部全程跟踪，尺寸由技术部出具为准。

安装方案

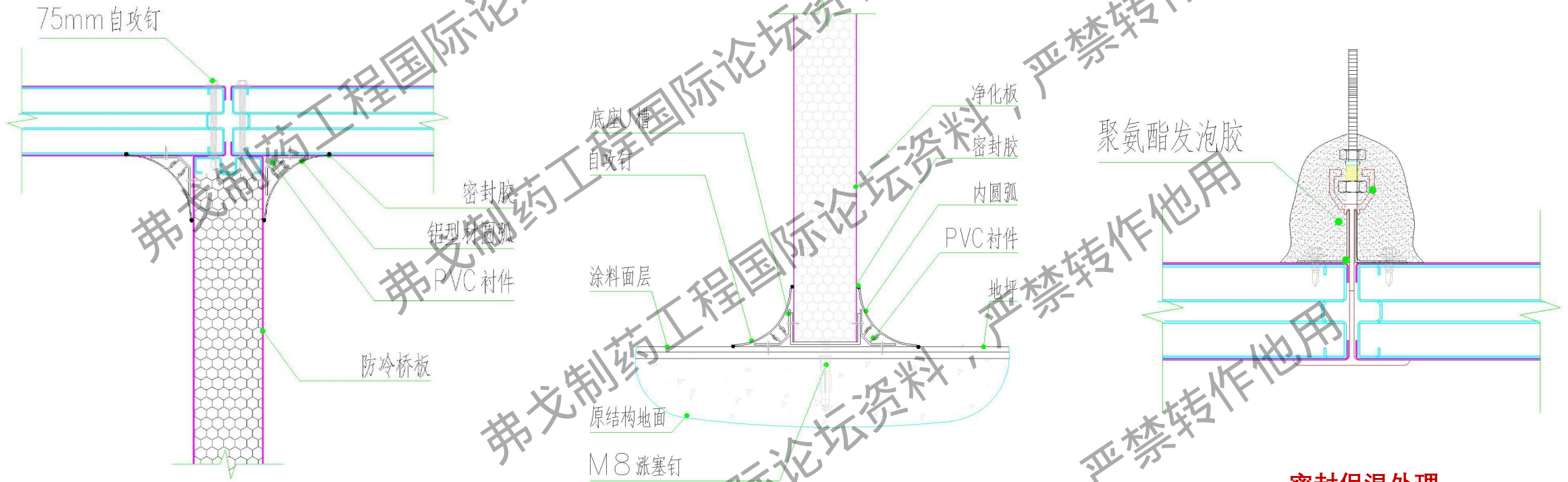

密封保温处理



弗戈制药工程国际论坛资料，严禁转作他用

弗戈制药工程国际论坛资料，严禁转作他用

弗戈制药工程国际论坛资料，严禁转作他用

弗戈制药工程国际论坛资料，严禁转作他用

弗戈制药工程国际论坛资料，严禁转作他用

弗戈制药工程国际论坛资料，严禁转作他用

中空回风单元模块

RETURN AIR WALL



- 此产品可以取代小房间（更衣脱鞋缓冲间）中的回风柱和100厚中空弹片墙。
- 把回风模块在工厂加工好，现场像手工洁净板一样拼接，安装方便快捷；
- 回风格栅可进行拆卸清洗，后期根据风量进行可调。



产品规格

事项	规格参数
宽度	970mm,1170mm
最大长度	6000mm
墙体厚度	100mm
外板材质	0.5mm 彩涂钢板/铝镁锰合金板/不锈钢板/钛锌板/VCM
芯材	石膏、铝蜂窝
龙骨厚度	0.8mm
回风量	500m ³ /h

备注：此板型由洁净技术部全程跟踪，尺寸由技术部出具为准。





回风单元结构图

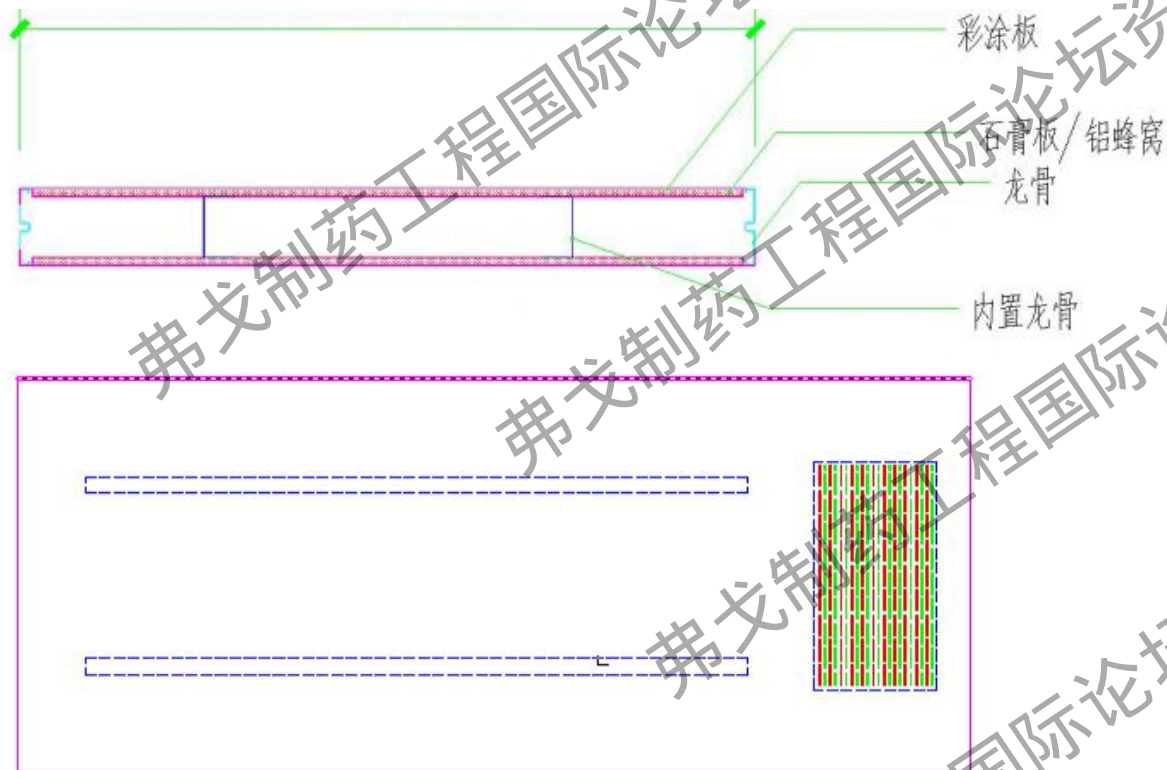



安装节点

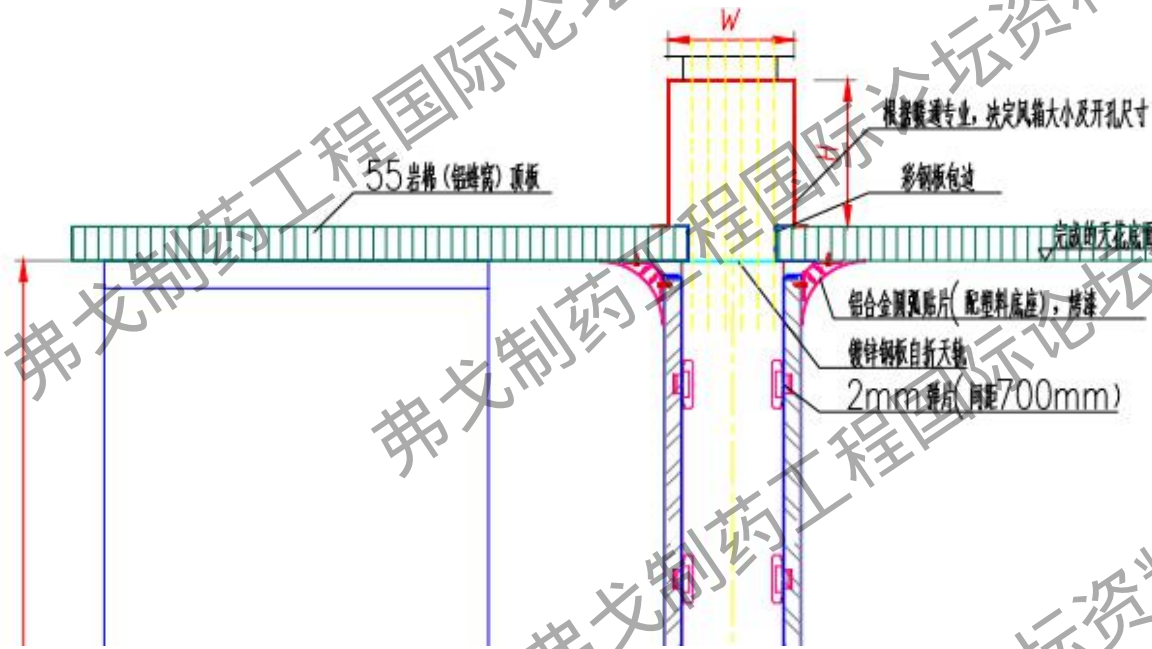

顶部与支管连接

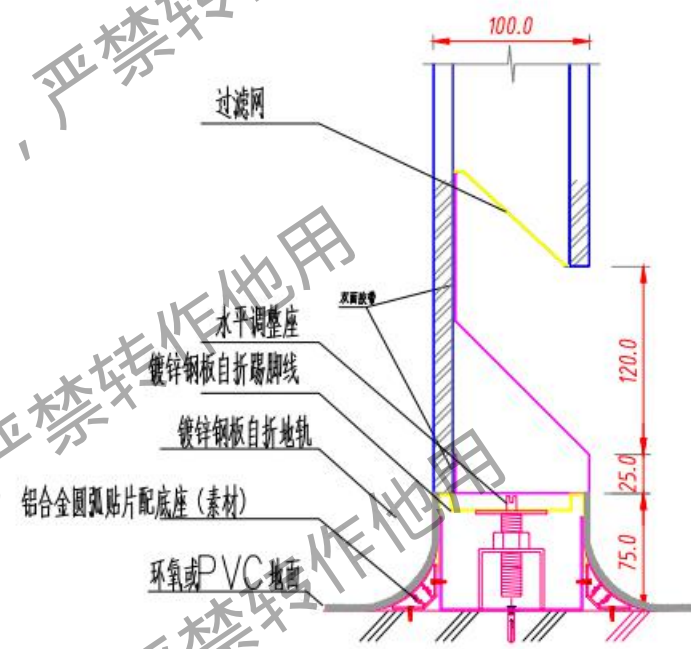

中空回风墙板与地面连接



弗戈制药工程国际论坛资料，严禁转作他用

弗戈制药工程国际论坛资料，严禁转作他用

弗戈制药工程国际论坛资料，严禁转作他用

弗戈制药工程国际论坛资料，严禁转作他用

弗戈制药工程国际论坛资料，严禁转作他用

弗戈制药工程国际论坛资料，严禁转作他用

中空回风夹道墙

HOLLOW RETURN AIR CLIP WALL



左侧中的图片为参观药玻工地所拍，目前回风夹道墙上的窗户采用2樘50mm厚的洁净视窗中间用洁净板进行四周密封处理制作而成。窗户成本高，现场施工效率低，3人一天制作4个窗口。



优化方案：

将回风夹道墙上的洁净视窗采用工厂预制装配模块化的方式进行集合，可以大大提高现场施工工人的工作效率，同时节省板材费用。

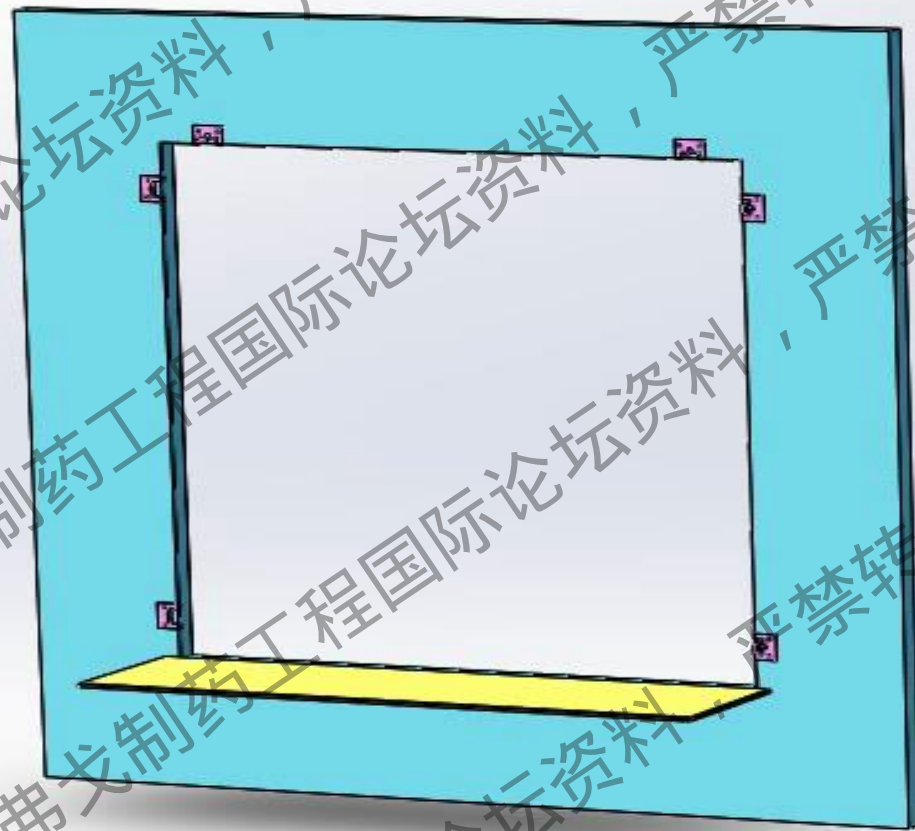



产品规格

事项	规格参数
窗规格	2360mm*1200mm
墙间距	350mm
回风夹道墙	盲板
盲板规格	2424mm (长) *348mm (宽) *10mm (厚) *2快 1180mm (长) *348mm (宽) *10mm (厚) *2快(可根据洞口尺寸进行定制)
板固定件&挂件芯材	16件

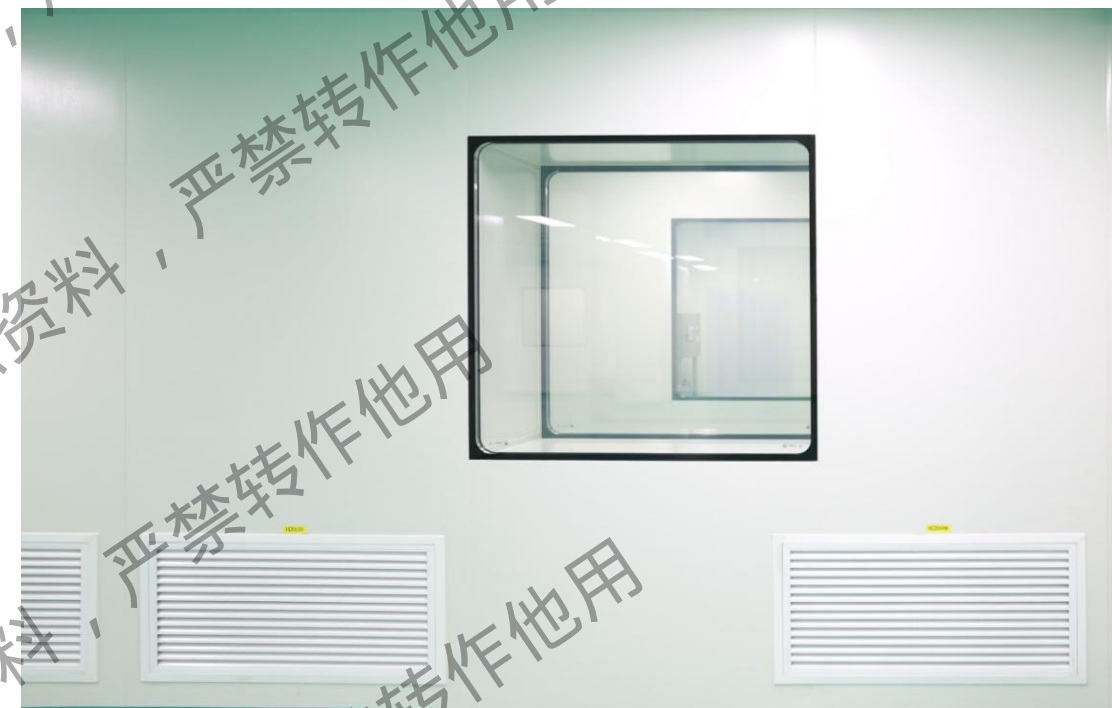

备注：此板型由洁净技术部全程跟踪，尺寸由技术部出具为准。



弗戈制药工程国际论坛资料，严禁转作他用

弗戈制药工程国际论坛资料，严禁转作他用

弗戈制药工程国际论坛资料，严禁转作他用

弗戈制药工程国际论坛资料，严禁转作他用

弗戈制药工程国际论坛资料，严禁转作他用

洁耐® 主要适用于生物制品、血液制品等洁净室B级区域下使用VHP消毒、酒精、新洁尔灭擦拭环境下的洁净室专用面板。在食品加工、冷库也广泛使用。

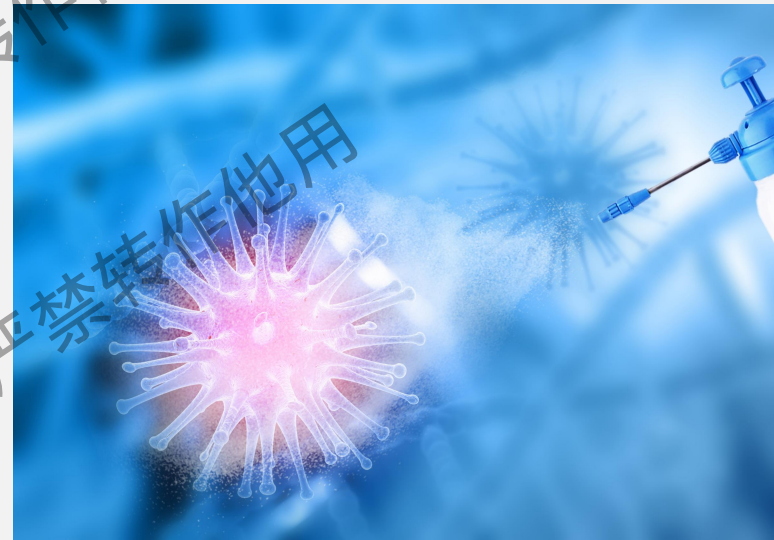



产品结构

工艺流程

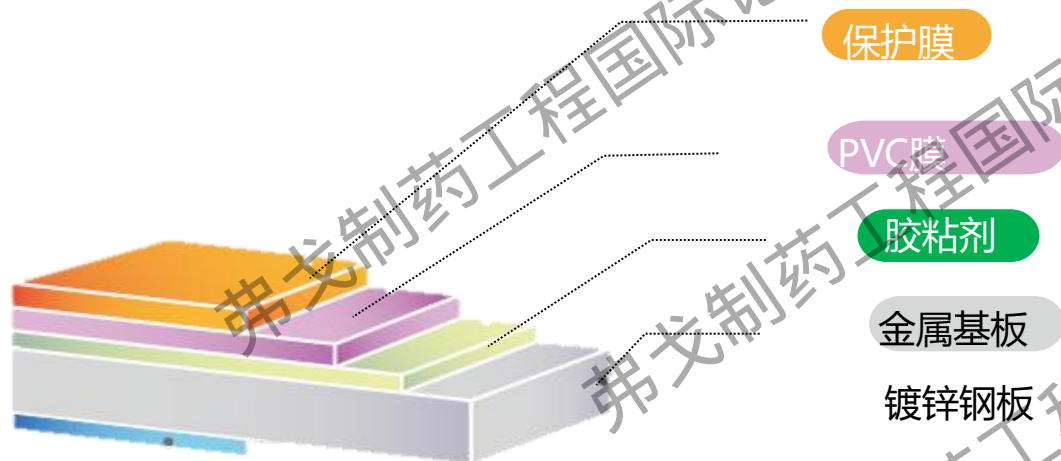

洁耐® 金属板产品结构图

覆膜金属板工艺流程

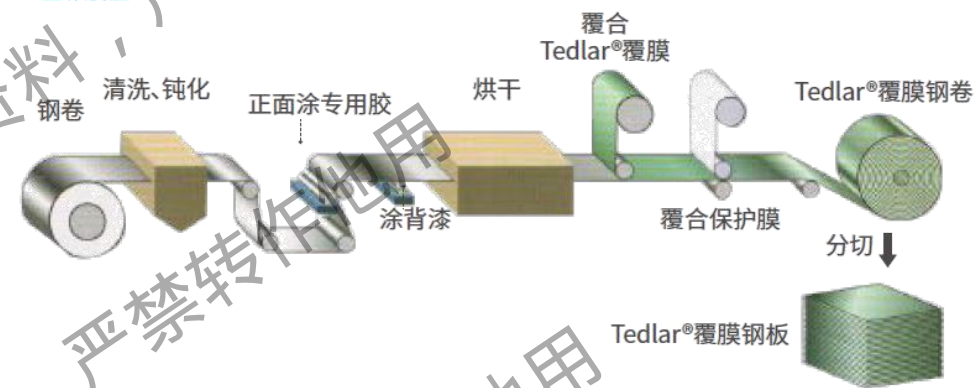

洁耐® 金属板工艺流程



耐化学性

耐磨性

易加工性

设计美观



洁耐®化学性能

30% H_2O_2 常温浸泡实验

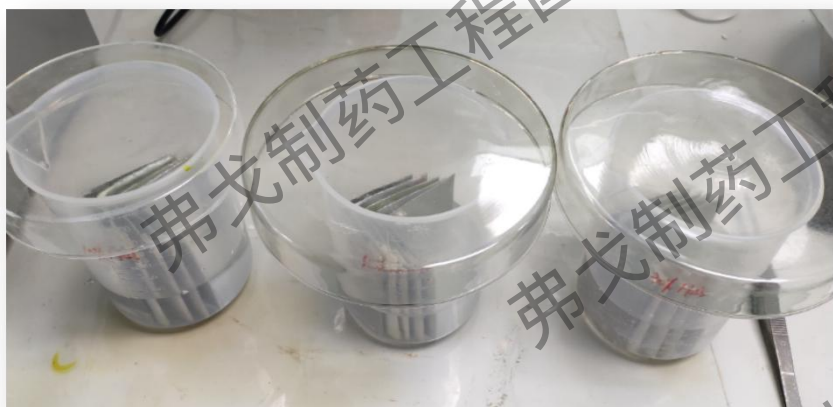



洁耐®化学性能

30% H_2O_2 滴扣实验

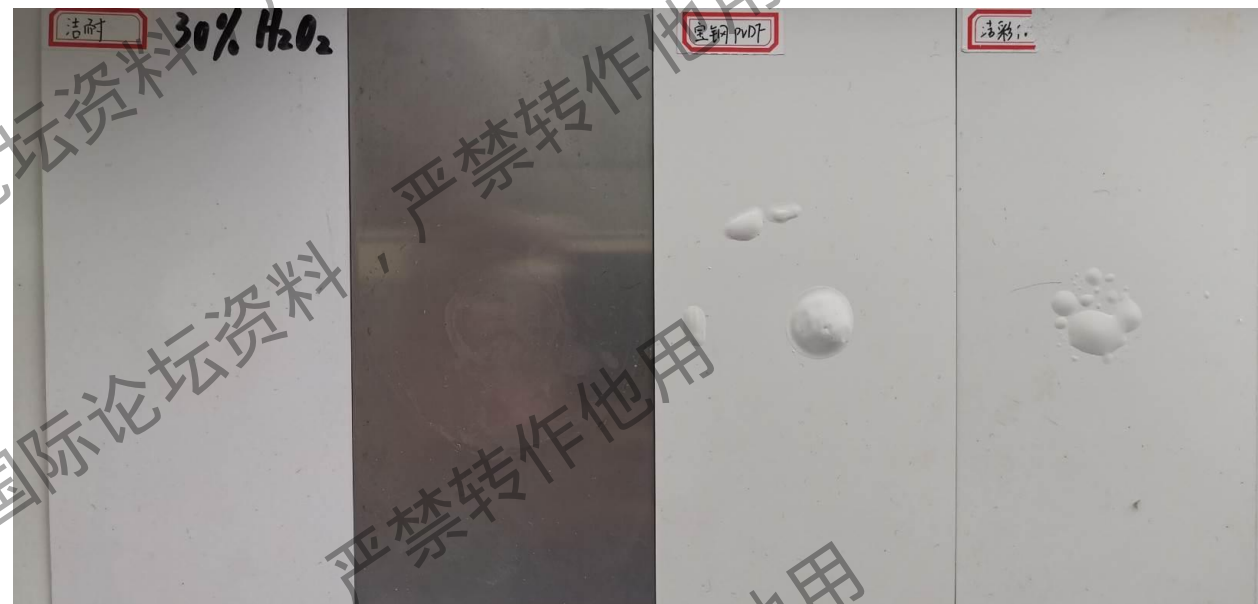

材质	洁耐®	PVDF	PE
实验结果	1608h (无变化)	96h(起泡)	16h (起泡)

弗戈制药工程国际论坛资料，严禁转作他用

弗戈制药工程国际论坛资料，严禁转作他用

弗戈制药工程国际论坛资料，严禁转作他用

弗戈制药工程国际论坛资料，严禁转作他用

弗戈制药工程国际论坛资料，严禁转作他用





洁耐®化学性能

10%HCL常温浸泡实验

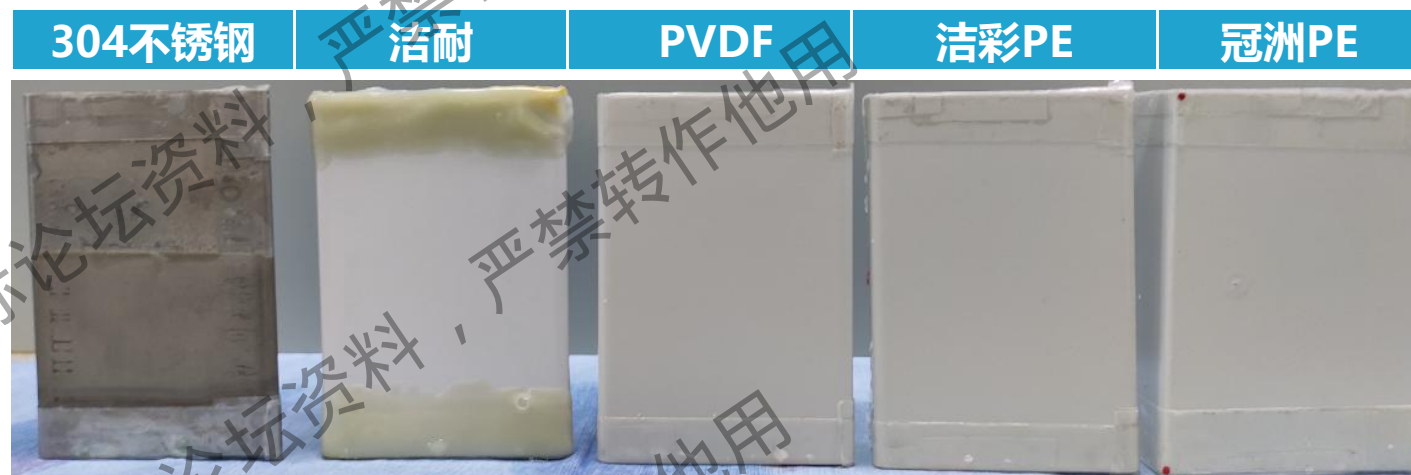
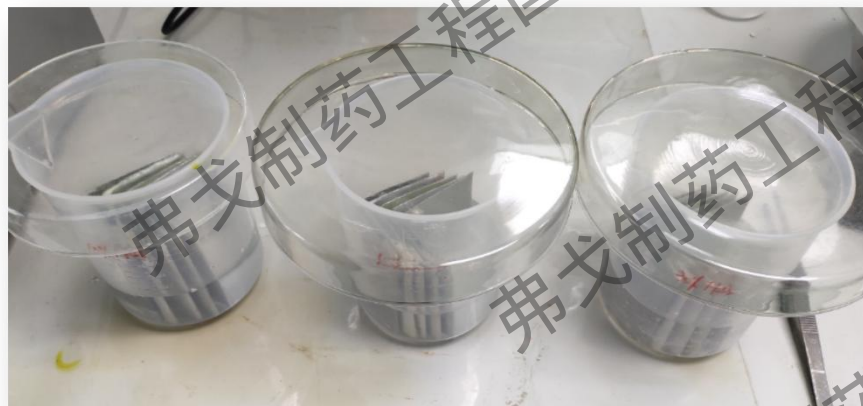

2h后没有明显变化



16h后腐蚀情况



洁耐®化学性能

10%NaOH常温浸泡实验

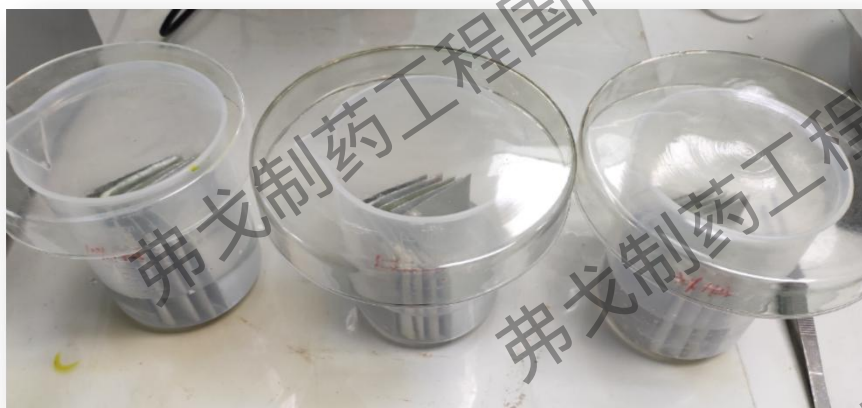

304不锈钢	洁耐	PVDF	洁彩PE	冠洲PE
--------	----	------	------	------

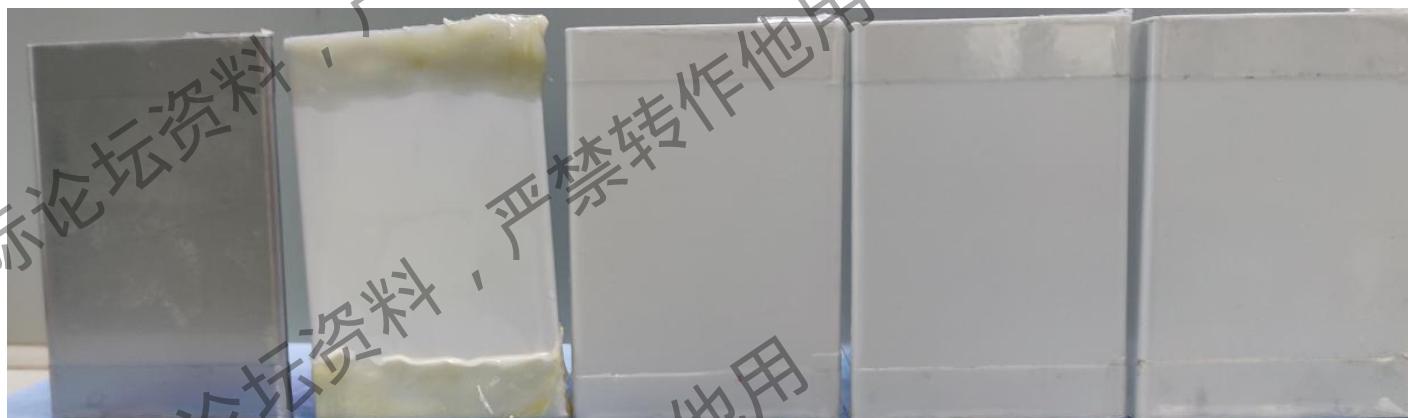

2h后没有明显变化

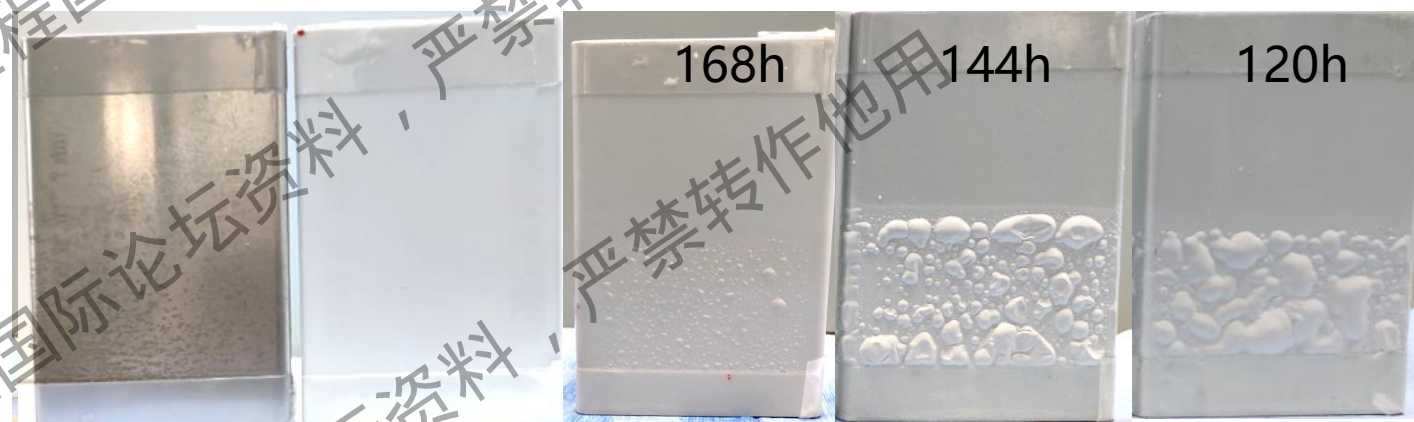



洁耐®物理性能

实验项目	洁耐®板	覆膜板	试验操作标准	试验判定标准
弯曲试验	0T	3T	GB/T 13448 - 2019	GB/T 12754 - 2019
划格试验	0级	0级	GB/T 13448 - 2019	GB/T 12754 - 2019
反向冲击试验	12J	12J	GB/T 13448 - 2019	GB/T 12754 - 2019

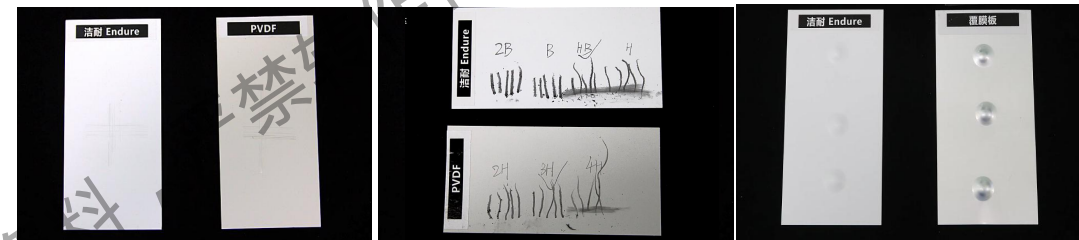

划格试验

铅笔硬度实验

反向冲击试验

实验项目	洁耐®板	PVDF板	试验操作标准	试验判定标准
弯曲试验	0T	3T	GB/T 13448 - 2019	GB/T 12754 - 2019
铅笔硬度试验	HB	3H	GB/T 13448 - 2019	GB/T 12754 - 2019
划格试验	0级	0级	GB/T 13448 - 2019	GB/T 12754 - 2019
反向冲击试验	12J	12J	GB/T 13448 - 2019	GB/T 12754 - 2019



洁耐®钢板

覆膜钢板

PVDF钢板

弯曲试验: 洁耐®板为0T, PVDF板和覆膜板为3T, 最高等级为0T。

划格试验: 洁耐®板、PVDF板和覆膜板均为0级, 最高等级为0级。

反向冲击试验: 洁耐®板、PVDF板和覆膜板均为12J, 最高等级为12J。

洁耐 Endure

覆膜板

洁耐板和覆膜板物理性能对比试验

Endure® Steel Sheet & Regular PVC Steel Sheet Physical Performance Comparison Test

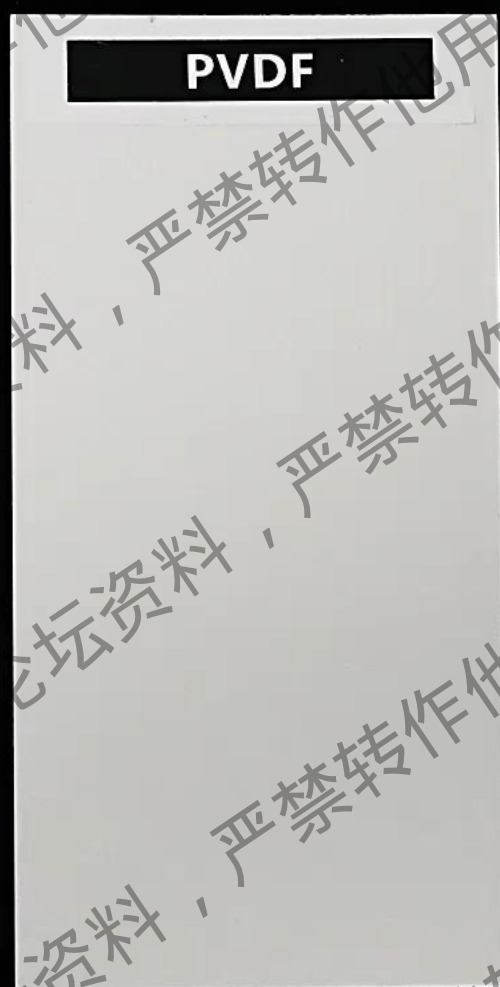
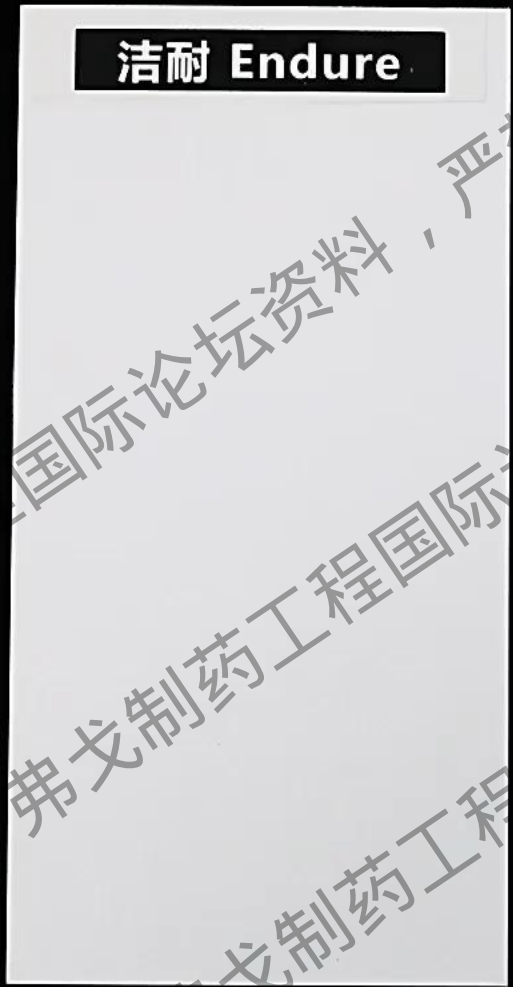

洁耐®板和PVDF板物理性能对比实验

Endure® Steel Sheet & PVDF Steel Sheet Physical Performance Comparison Test



洁耐®设计美观

色差小

洁耐用薄膜同批次色差 $\Delta E < 0.3$ ，不同批次色差 $\Delta E < 0.5$

饰面哑光、光泽度8-10

面层哑光设计，视觉效果好，表面均匀细腻、质感好





WISKIND

大师系列洁净门

MASTER SERIES CLEAN ROOM DOOR

弗戈制药工程国际论坛资料，严禁转作他用

弗戈制药工程国际论坛资料，严禁转作他用

弗戈制药工程国际论坛资料，严禁转作他用

弗戈制药工程国际论坛资料，严禁转作他用



产品规格

事项	规格参数
规格	900mm*2100mm,1000mm*2100mm 1500mm*2100mm,1800mm*2100mm
门框板材厚度	镀锌板1.5mm
门扇板材厚度	镀锌板1.0mm
芯材	纸蜂窝、铝蜂窝
视窗	外直内直、外直内圆、外圆内圆 印边：黑色、白色 (400mm*600mm)
锁具	GEZE不锈钢执手锁
合页	万事达不锈钢合页

备注：此板型由洁净技术部全程跟踪，尺寸由技术部出具为准





弗戈制药工程国际论坛资料，严禁转作他用

弗戈制药工程国际论坛资料，严禁转作他用

暗藏无边框门

HIDDEN FRAME DOOR

弗戈制药工程国际论坛资料，严禁转作他用



问题点

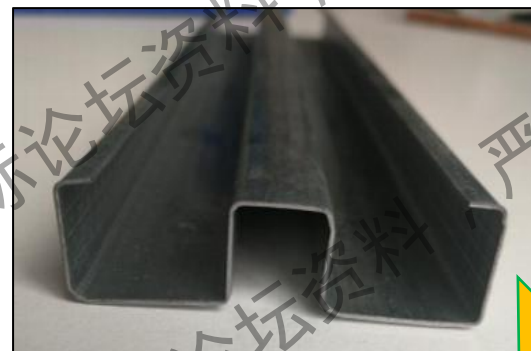

龙骨厚度
0.6-0.8mm



GB/T 15856.4-1995				
螺纹规格	ST3.5	ST4.2	ST4.8	ST5.5
P	1.3	1.4	1.6	1.8





产品规格

事项	规格参数
规格	900mm*2100mm,1000mm*2100mm 1500mm*2100mm,1800mm*2100mm
门框板材厚度	镀锌板1.5mm
门扇板材厚度	镀锌板0.8mm
芯材	纸蜂窝、铝蜂窝
视窗	外直内直、外直内圆、外圆内圆 印边：黑色、白色 (400mm*600mm)
锁具	GEZE不锈钢执手锁
合页	不锈钢合页





WISKIND

大师系列洁净窗

MASTER SERIES CLEAN ROOM WINDOW



窗子 为什么会结露？



产品规格

事项	规格参数
宽度	1180mm*1200mm, 2363mm*1200mm
窗框	铝合金窗框
视窗厚度	50mm
填充	3A级分子筛
结构	直角、外直内圆
印边颜色	黑色、白色
适用场所	制药洁净室、电子洁净室、食品洁净室等



备注：此板型由洁净技术部全程跟踪，尺寸由技术部出具为准



洁创

OPENABLE CLEANROOM WINDOW

Display Cleanroom Window

万事达·洁创™





产品规格

事项	规格参数
宽度	1200mmx1180mm 2360mmx1200mm 可定制
玻璃	钢化玻璃
展示形式	平板告示类/展品展格
照明	LED灯
结构	直角
窗框	白色/黑色
打开方式	电动
适用场所	洁净参观走廊



备注：此板型由洁净技术部全程跟踪，尺寸由技术部出具为准。



弗戈制药工程国际论坛资料，严禁转作他用

环境友好化

ENVIRONMENTALLY FRIENDLY



环境友好?







WISKIND



不同的色彩能引起人们不同的工作效果和心理效应



环境友好化是未来洁净室不可缺少的一步



弗戈制药工程国际论坛资料，严禁转作他用

弗戈制药工程国际论坛资料，严禁转作他用

弗戈制药工程国际论坛资料，严禁转作他用

弗戈制药工程国际论坛资料，严禁转作他用

弗戈制药工程国际论坛资料，严禁转作他用



弗戈制药工程国际论坛资料，严禁转作他用

弗戈制药工程国际论坛资料，严禁转作他用

洁净空间智慧设计系统

CLEANROOM SPACE INTELLIGENT DESIGN

弗戈制药工程国际论坛资料，严禁转作他用

弗戈制药工程国际论坛资料，严禁转作他用

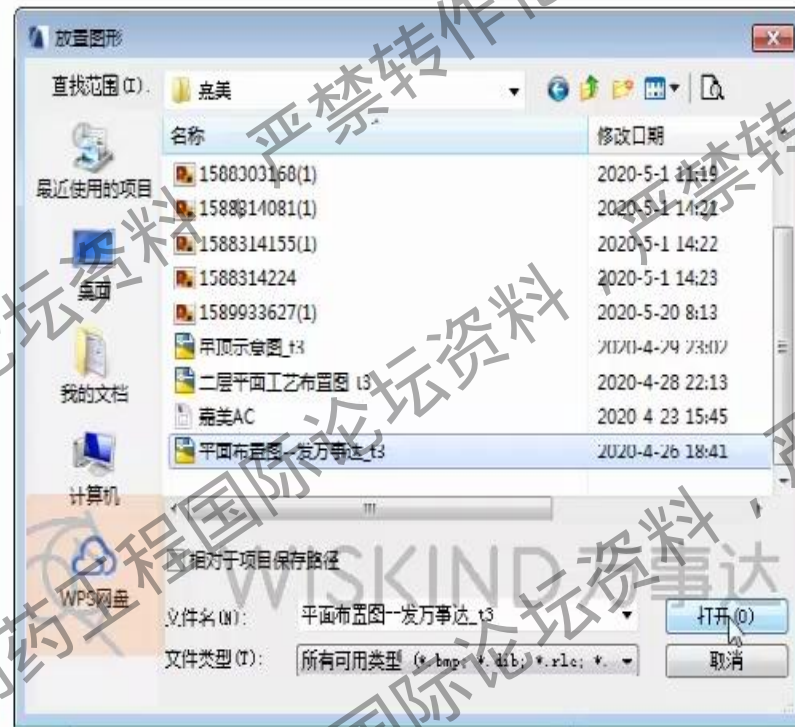

弗戈制药工程国际论坛资料，严禁转作他用

弗戈制药工程国际论坛资料，严禁转作他用

弗戈制药工程国际论坛资料，严禁转作他用

弗戈制药工程国际论坛资料，严禁转作他用

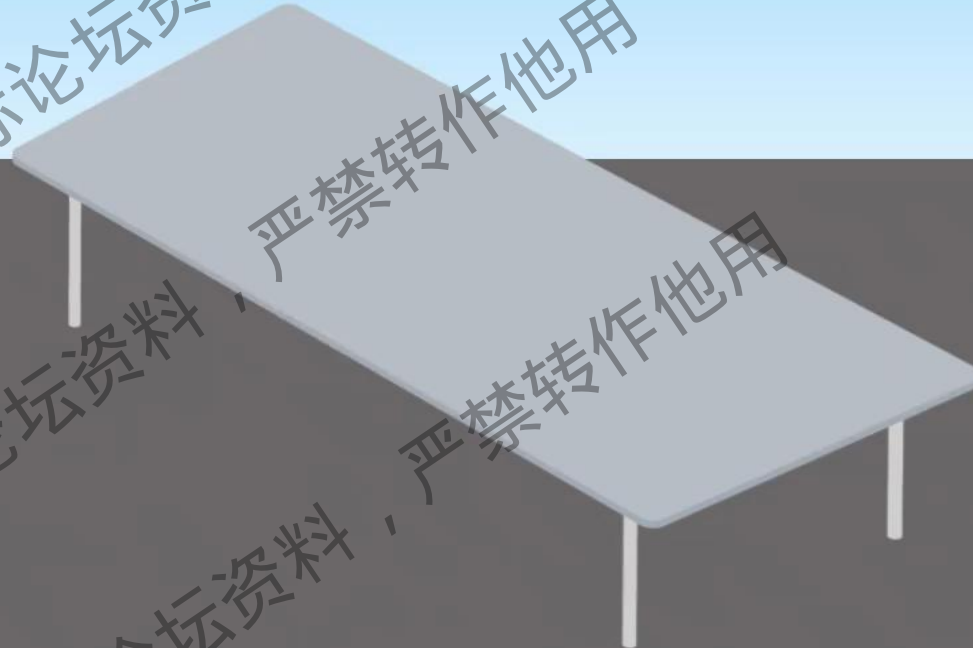

WISKIND



弗戈制药工程国际论坛资料，严禁转作他用

弗戈制药工程国际论坛资料，严禁转作他用

弗戈制药工程国际论坛资料，严禁转作他用

弗戈制药工程国际论坛资料，严禁转作他用

弗戈制药工程国际论坛资料，严禁转作他用

弗戈制药工程国际论坛资料，严禁转作他用

智能交付

INTELLIGENT DELIVERY



弗戈制药工程国际论坛资料，严禁转作他用

客户需要看得见，我们递送能追踪





WISKIND

合作伙伴

Wiskind Partner

- 生物制药
- 食品安全
- 电子行业





WISKIND

战略合作伙伴

SANDWICH PANEL

医药工程案例



WISKIND





WISKIND



食品安全工程案例





WISKIND



电子工程案例





THANK YOU



山东万事达建筑钢品股份有限公司

中国山东省博兴经济开发区兴博五路800号

T 400 1588 600

www.wiskind.com.cn